

# 2021 BRUTE FORCE® 750 4x4i EPS PARTS DIAGRAM

Flap

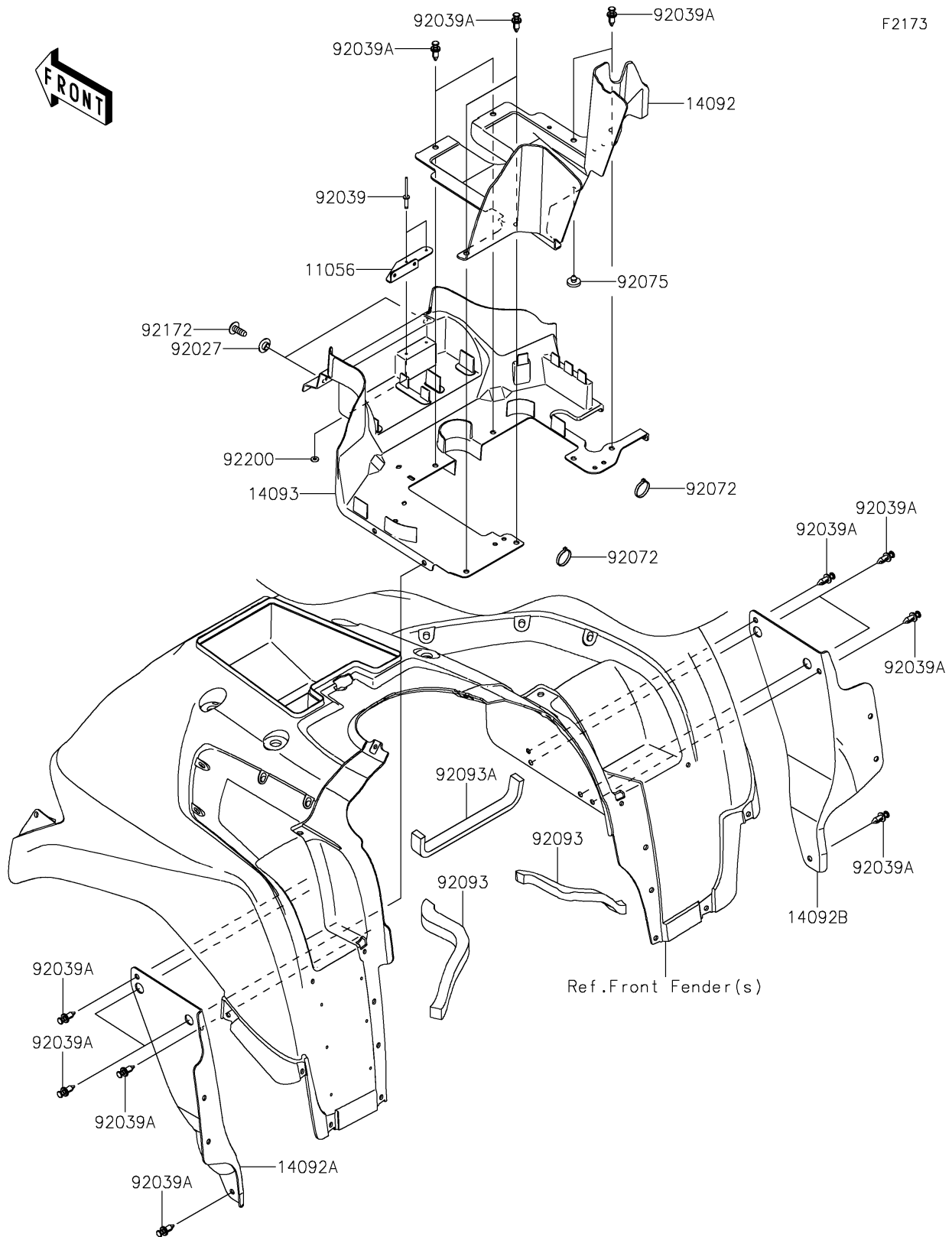

## 2021 BRUTE FORCE® 750 4x4i EPS PARTS LIST

### Flap

ITEM NAME	PART NUMBER	QUANTITY
BRACKET,V.D. SENSOR (Ref # 11056)	11056-0956	1
COVER, TOP INNER, RR (Ref # 14092)	14092-0182	1
COVER, SIDE INNER, LH (Ref # 14092A)	14092-0183	1
COVER, SIDE INNER, RH (Ref # 14092B)	14092-0184	1
COVER, TOP INNER, FR (Ref # 14093)	14093-0022	1
COLLAR (Ref # 92027)	92027-4020	2
RIVET (Ref # 92039)	92039-0031	2
RIVET (Ref # 92039A)	92039-0776	16
BAND, L=292.1 (Ref # 92072)	92072-3509	2
DAMPER, BOOST SENSOR (Ref # 92075)	92075-2113	1
SEAL, 20X270X30 (Ref # 92093)	92093-0570	2
SEAL, 20X300X20 (Ref # 92093A)	92093-0571	1
SCREW, TAPPING, 6X16 (Ref # 92172)	92172-0739	2
WASHER, 3.5X8X1 (Ref # 92200)	92200-1251	2