

2021 BRUTE FORCE® 750 4x4i EPS PARTS DIAGRAM

Fuel Injection

E1530

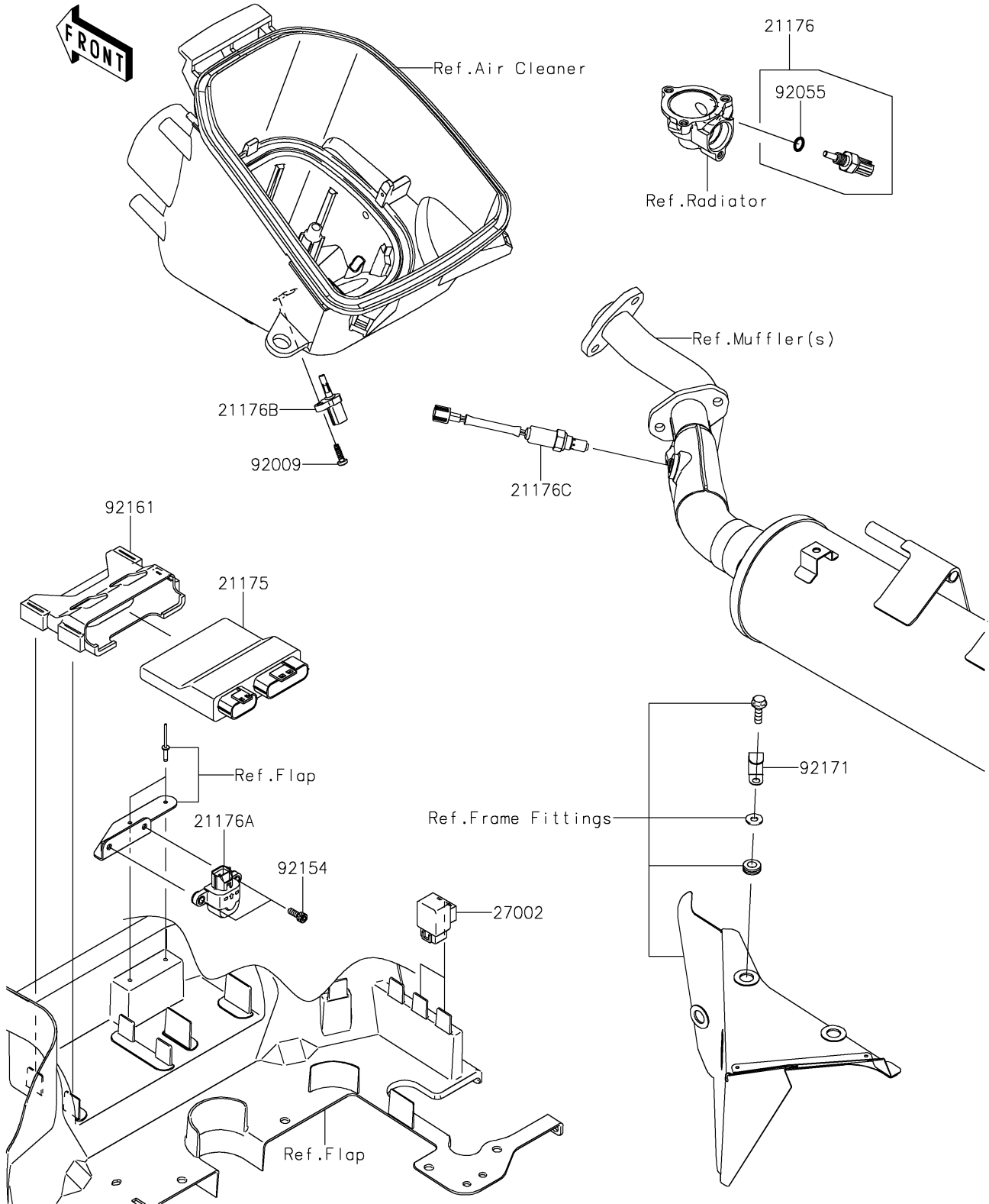

2021 BRUTE FORCE® 750 4x4i EPS PARTS LIST

Fuel Injection

ITEM NAME	PART NUMBER	QUANTITY
CONTROL UNIT-ELECTRONIC (Ref # 21175)	21175-0843	1
SENSOR,WATER TEMP (Ref # 21176)	21176-0009	1
SENSOR,VEHICLE-DOWN (Ref # 21176A)	21176-0026	1
SENSOR,AIR TEMPERATURE (Ref # 21176B)	21176-0048	1
SENSOR,OXYGEN (Ref # 21176C)	21176-0744	1
RELAY-ASSY (Ref # 27002)	27002-1062	2
SCREW,TAPPING,5X16 (Ref # 92009)	92009-1984	1
RING-O,9.5X1.9 (Ref # 92055)	92055-0016	1
BOLT,SOCKET,5X14 (Ref # 92154)	92154-1841	2
DAMPER (Ref # 92161)	92161-0465	1
CLAMP (Ref # 92171)	92171-0739	1