

2020 MULE PRO-MX™ EPS CAMO PARTS DIAGRAM

Cylinder/Piston(s)

E1120

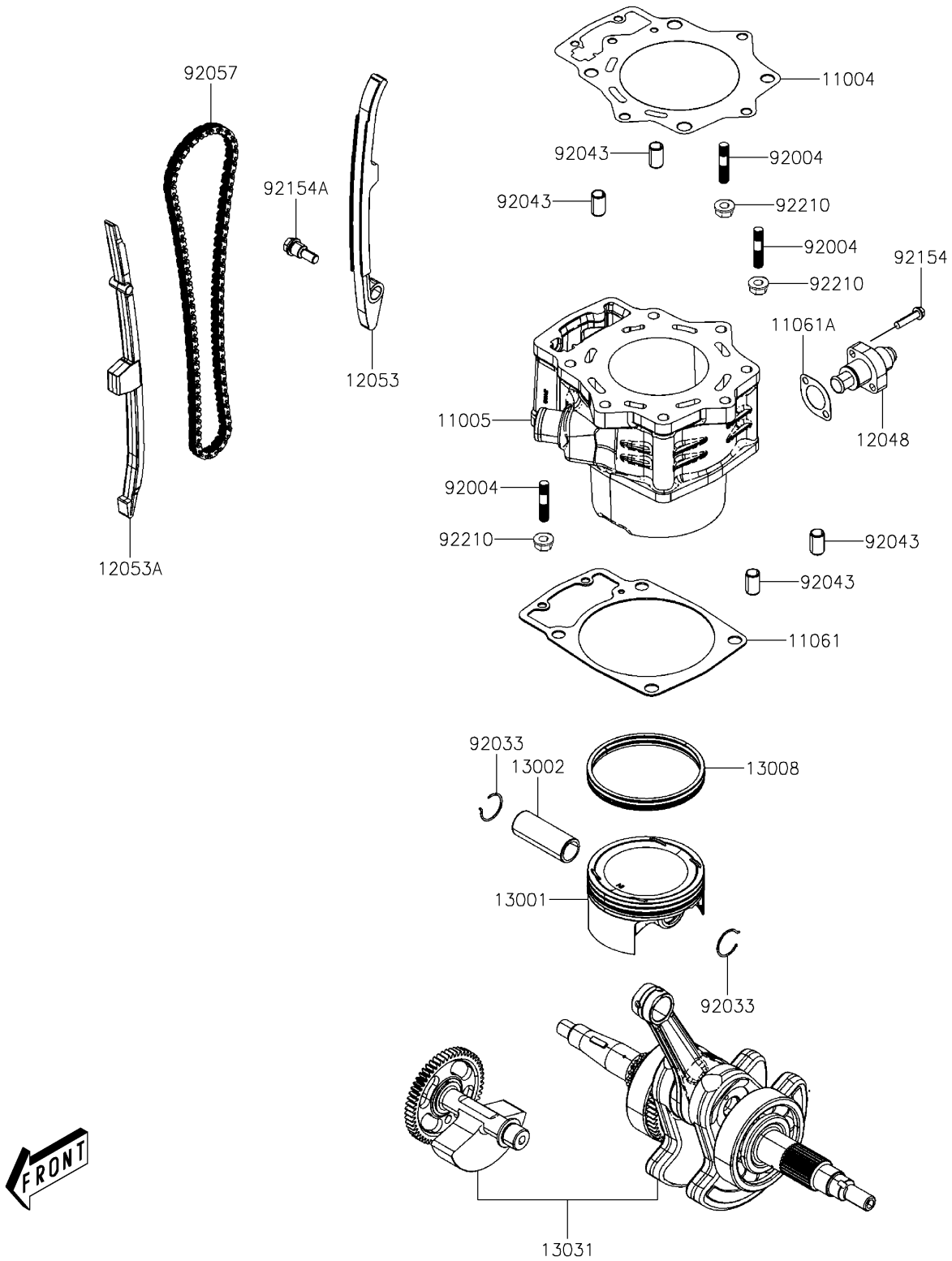

2020 MULE PRO-MX™ EPS CAMO PARTS LIST

Cylinder/Piston(s)

ITEM NAME	PART NUMBER	QUANTITY
GASKET-HEAD (Ref # 11004)	11004-Y006	1
CYLINDER-ENGINE (Ref # 11005)	11005-Y006	1
GASKET,CYLINDER BASE (Ref # 11061)	11061-Y062	1
GASKET,TENSIONER (Ref # 11061A)	11061-Y063	1
TENSIONER-ASSY (Ref # 12048)	12048-Y007	1
GUIDE-CHAIN,TENSIONER (Ref # 12053)	12053-Y011	1
GUIDE-CHAIN,CAM CHAIN (Ref # 12053A)	12053-Y012	1
PISTON-ENGINE (Ref # 13001)	13001-Y006	1
PIN-PISTON (Ref # 13002)	13002-Y006	1
RING-SET-PISTON (Ref # 13008)	13008-Y006	1
CRANKSHAFT-COMP (Ref # 13031)	13031-Y006	1
STUD,8X40 (Ref # 92004)	92004-Y019	1
RING-SNAP (Ref # 92033)	92033-Y044	1
PIN,12X20 (Ref # 92043)	92043-Y027	1
CHAIN,CAM (Ref # 92057)	92057-Y011	1
BOLT,FLANGE,6X25 (Ref # 92154)	92154-Y066	1
BOLT,CAM CHAIN TENSIONER (Ref # 92154A)	92154-Y164	1
NUT,8MM (Ref # 92210)	92210-Y028	1