

2020 MULE SX™ 4x4 XC LE FI PARTS DIAGRAM

Oil Pump/Oil Filter

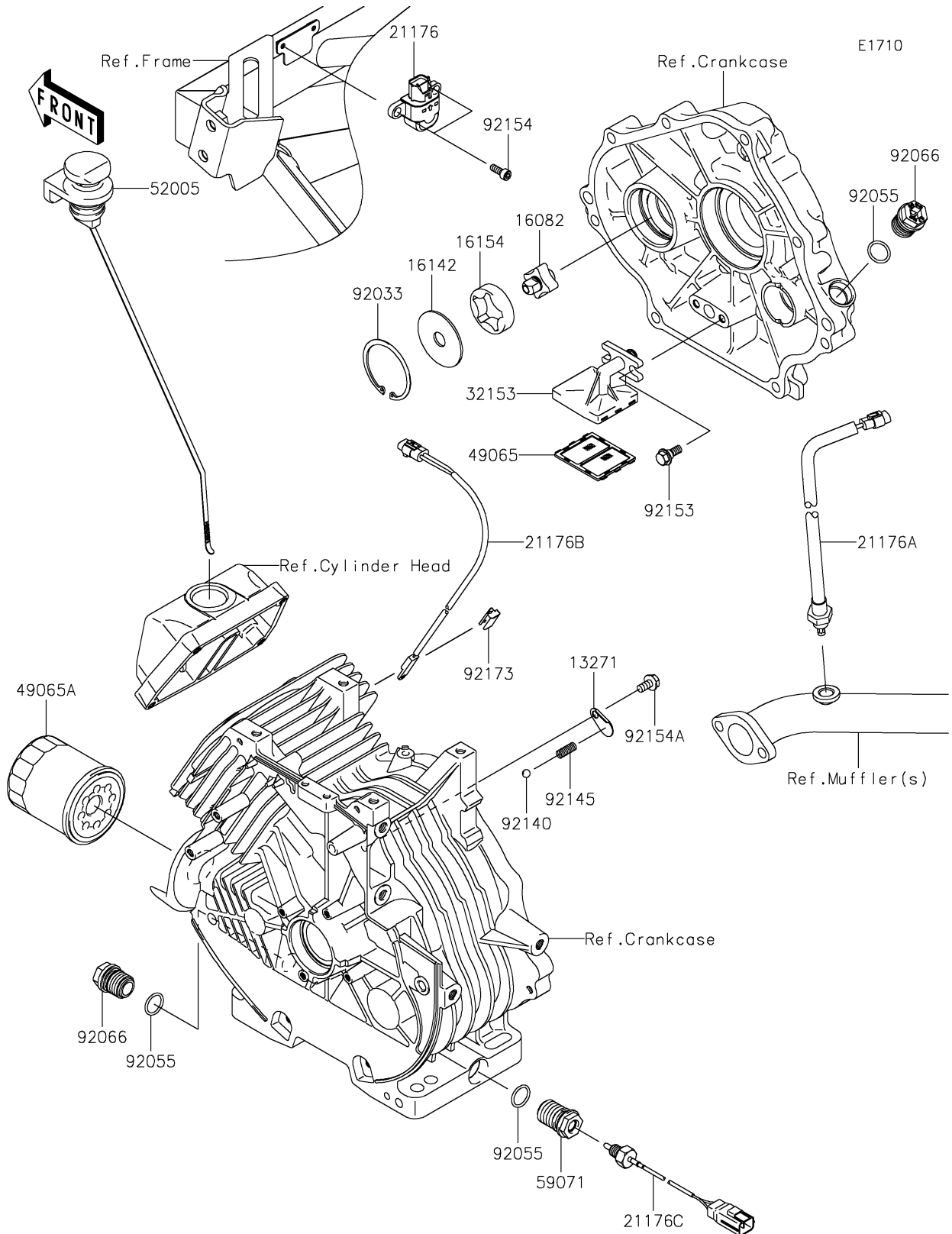

2020 MULE SX™ 4x4 XC LE FI PARTS LIST

Oil Pump/Oil Filter

ITEM NAME	PART NUMBER	QUANTITY
PLATE,OIL RELIEF (Ref # 13271)	13271-7026	1
PUMP-ASSY-OIL (Ref # 16082)	16082-0760	1
COVER-PUMP (Ref # 16142)	16142-0745	1
ROTOR-PUMP,OUT (Ref # 16154)	16154-2054	1
SENSOR,VEHICLE-DOWN (Ref # 21176)	21176-0026	1
SENSOR,OXYGEN (Ref # 21176A)	21176-0873	1
SENSOR,TEMP (Ref # 21176B)	21176-0879	1
SENSOR,OIL TEMP (Ref # 21176C)	21176-2108	1
PIPE (Ref # 32153)	32153-7002	1
FILTER-OIL (Ref # 49065)	49065-0717	1
FILTER-OIL (Ref # 49065A)	49065-7010	1
GAUGE,OIL LEVEL (Ref # 52005)	52005-7020	1
JOINT,SENSOR (Ref # 59071)	59071-0745	1
RING-SNAP (Ref # 92033)	92033-7008	1
RING-O,15.8X2.4 (Ref # 92055)	92055-0892	1
PLUG (Ref # 92066)	92066-0774	1
BALL (Ref # 92140)	92140-7001	1
SPRING,OIL RELIEF (Ref # 92145)	92145-1807	1
BOLT,FLANGED,6X16 (Ref # 92153)	92153-7007	1
BOLT,SOCKET,5X14 (Ref # 92154)	92154-1841	1
BOLT,6X12 (Ref # 92154A)	92154-2938	1
CLAMP,TEMP SENSOR (Ref # 92173)	92173-1905	1