

2017 TERYX4™ PARTS DIAGRAM

Front Box

F2135

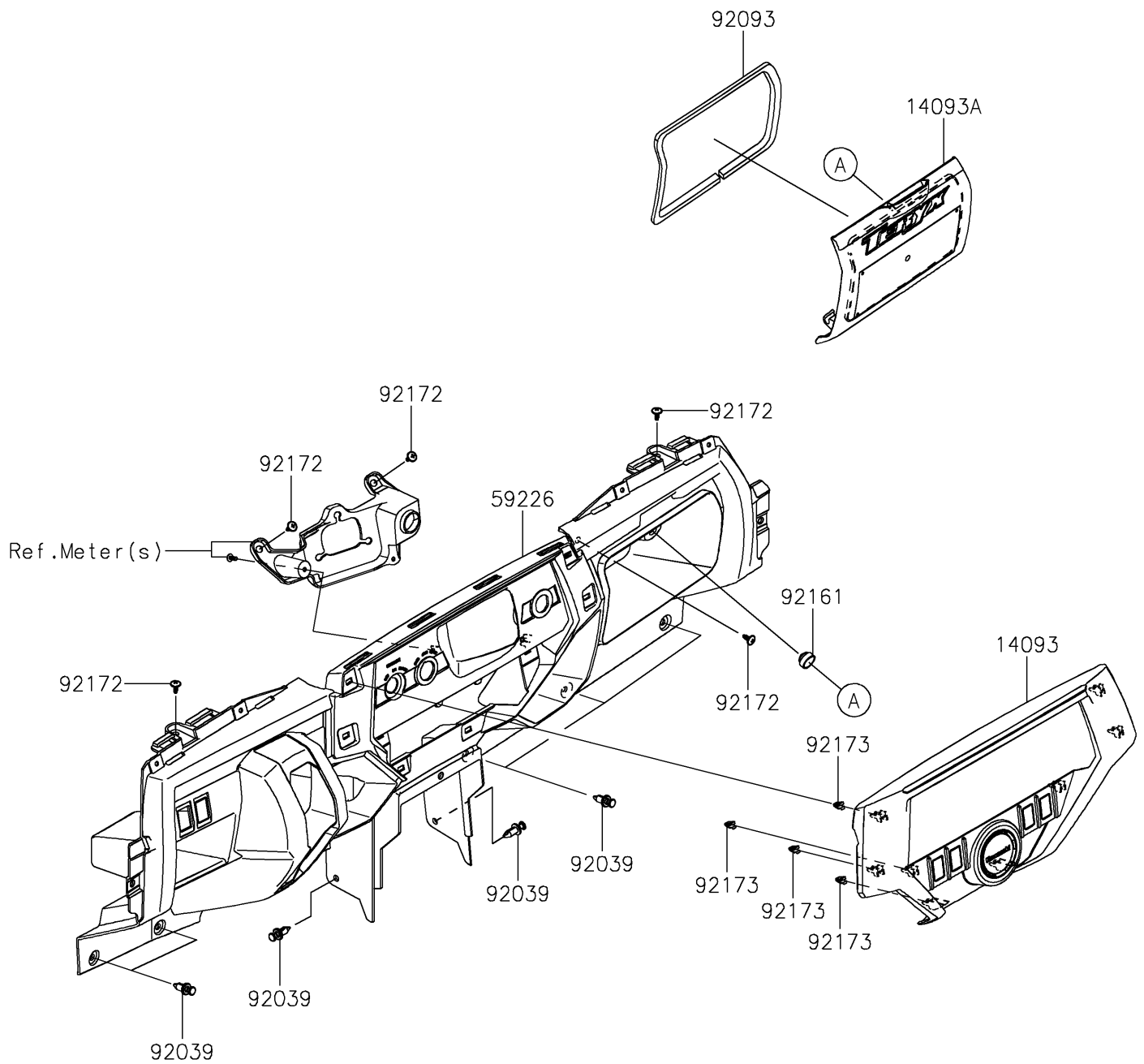

2017 TERYX4™ PARTS LIST

Front Box

ITEM NAME	PART NUMBER	QUANTITY
COVER,CENTER PANEL (Ref # 14093)	14093-0203	1
COVER,GLOVE BOX (Ref # 14093A)	14093-0204	1
PANEL-CONTROL (Ref # 59226)	59226-0727	1
RIVET (Ref # 92039)	92039-0776	1
SEAL,6X10 (Ref # 92093)	92093-0658	1
DAMPER (Ref # 92161)	92161-0568	1
SCREW,6X16 (Ref # 92172)	92172-0826	1
CLAMP (Ref # 92173)	92173-1423	1