

2019 W175 SE (Indonesia Only) PARTS DIAGRAM

Side Covers/Chain Cover

F2610

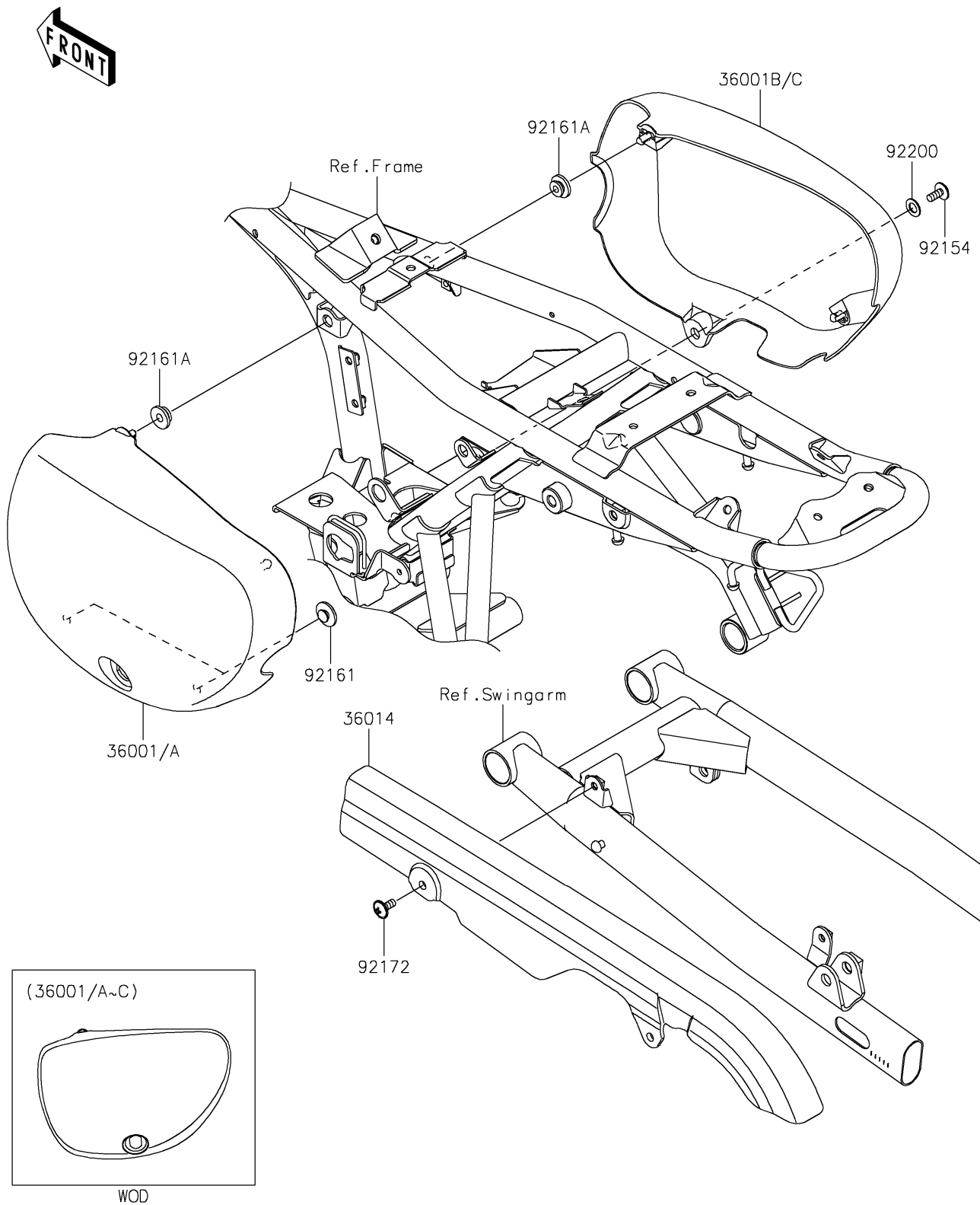

2019 W175 SE (Indonesia Only) PARTS LIST

Side Covers/Chain Cover

ITEM NAME	PART NUMBER	QUANTITY
COVER-SIDE,LH,M.F.S.BLACK (Ref # 36001)	36001-0654-739	1
COVER-SIDE,RH,M.F.S.BLACK (Ref # 36001B)	36001-0655-739	1
CASE-CHAIN (Ref # 36014)	36014-0570	1
BOLT,SOCKET,6X14 (Ref # 92154)	92154-1208	1
DAMPER,8X22X10 (Ref # 92161)	92161-1685	1
DAMPER (Ref # 92161A)	92161-1810	1
SCREW,6X14 (Ref # 92172)	92172-1197	1
WASHER,9X18X1 (Ref # 92200)	92200-1977	1