

2015 Ninja® 300 SE PARTS DIAGRAM

Suspension/Shock Absorber

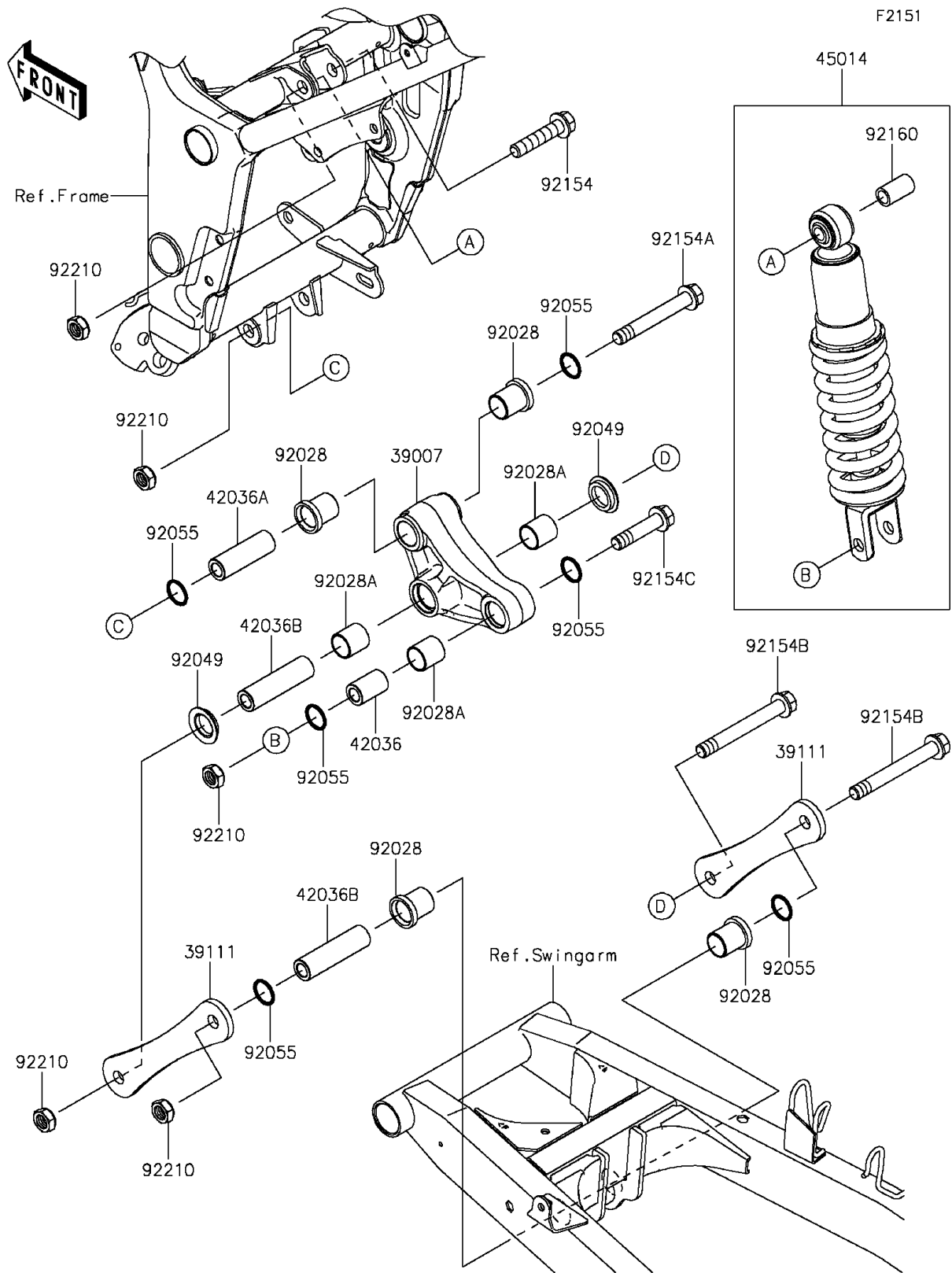

2015 Ninja® 300 SE PARTS LIST

Suspension/Shock Absorber

ITEM NAME	PART NUMBER	QUANTITY
ARM-SUSP,UNI TRAK (Ref # 39007)	39007-0355	1
ROD-TIE,SUSPENSION (Ref # 39111)	39111-0076	1
SLEEVE,12.1X20X32 (Ref # 42036)	42036-1077	1
SLEEVE,ARM,FR (Ref # 42036A)	42036-1078	1
SLEEVE,12.1X20X74 (Ref # 42036B)	42036-1102	1
SHOCKABSORBER,BLACK+BLACK (Ref # 45014)	45014-0438-37S	1
BUSHING (Ref # 92028)	92028-1597	1
BUSHING (Ref # 92028A)	92028-1598	1
SEAL-OIL,ARM (Ref # 92049)	92049-1109	1
RING-O,19.8X2.2 (Ref # 92055)	92055-0732	1
BOLT,FLANGED,12X55 (Ref # 92154)	92154-0362	1
BOLT,FLANGED,12X86 (Ref # 92154A)	92154-0940	1
BOLT,FLANGED,12X98 (Ref # 92154B)	92154-0941	1
BOLT,FLANGED,12X52 (Ref # 92154C)	92154-0942	1
DAMPER,SHOCKABSORBER (Ref # 92160)	92160-1161	1
NUT,LOCK,12MM (Ref # 92210)	92210-1247	1