

2011 KX™450F PARTS DIAGRAM

Clutch

E1350

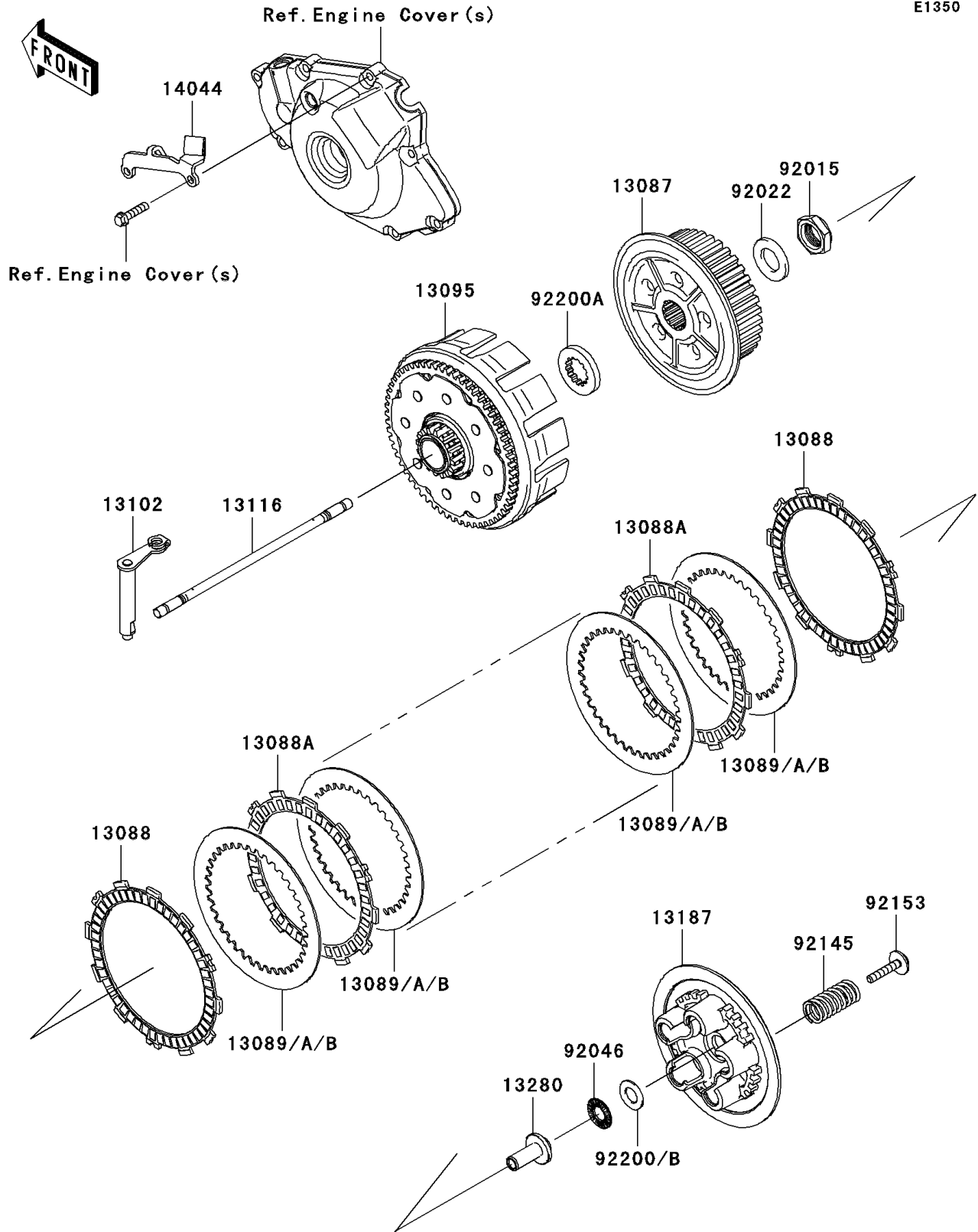

2011 KX™450F PARTS LIST

Clutch

ITEM NAME	PART NUMBER	QUANTITY
HUB-CLUTCH (Ref # 13087)	13087-0015	1
PLATE-FRICTION (Ref # 13088)	13088-0010	1
PLATE-FRICTION (Ref # 13088A)	13088-0051	1
PLATE-CLUTCH,T=2.0 (Ref # 13089)	13089-1005	1
PLATE-CLUTCH,T=1.2 (Ref # 13089A)	13089-1010	1
PLATE-CLUTCH,T=1.6 (Ref # 13089B)	13089-1095	1
HOUSING-COMP-CLUTCH (Ref # 13095)	13095-0122	1
RELEASE-COMP-CLUTCH (Ref # 13102)	13102-0035	1
ROD-PUSH (Ref # 13116)	13116-0013	1
PLATE-CLUTCH OPERATING (Ref # 13187)	13187-0018	1
HOLDER (Ref # 13280)	13280-0351	1
HOLDER-CABLE (Ref # 14044)	14044-0038	1
NUT,20MM (Ref # 92015)	92015-1725	1
WASHER,20.3X36X3.7 (Ref # 92022)	92022-1868	1
BEARING-NEEDLE,FNTA-1326 (Ref # 92046)	92046-1190	1
SPRING,CLUTCH (Ref # 92145)	92145-0370	1
BOLT,WP,6X35 (Ref # 92153)	92153-1876	1
WASHER,13.4X25X1.0 (Ref # 92200)	92200-0045	1
WASHER,25X41X5.5 (Ref # 92200A)	92200-0245	1
WASHER,13.4X25.0X1.5 (Ref # 92200B)	92200-1548	1