

2010 Concours® 14 ABS PARTS DIAGRAM

Camshaft(s)/Tensioner

E1230

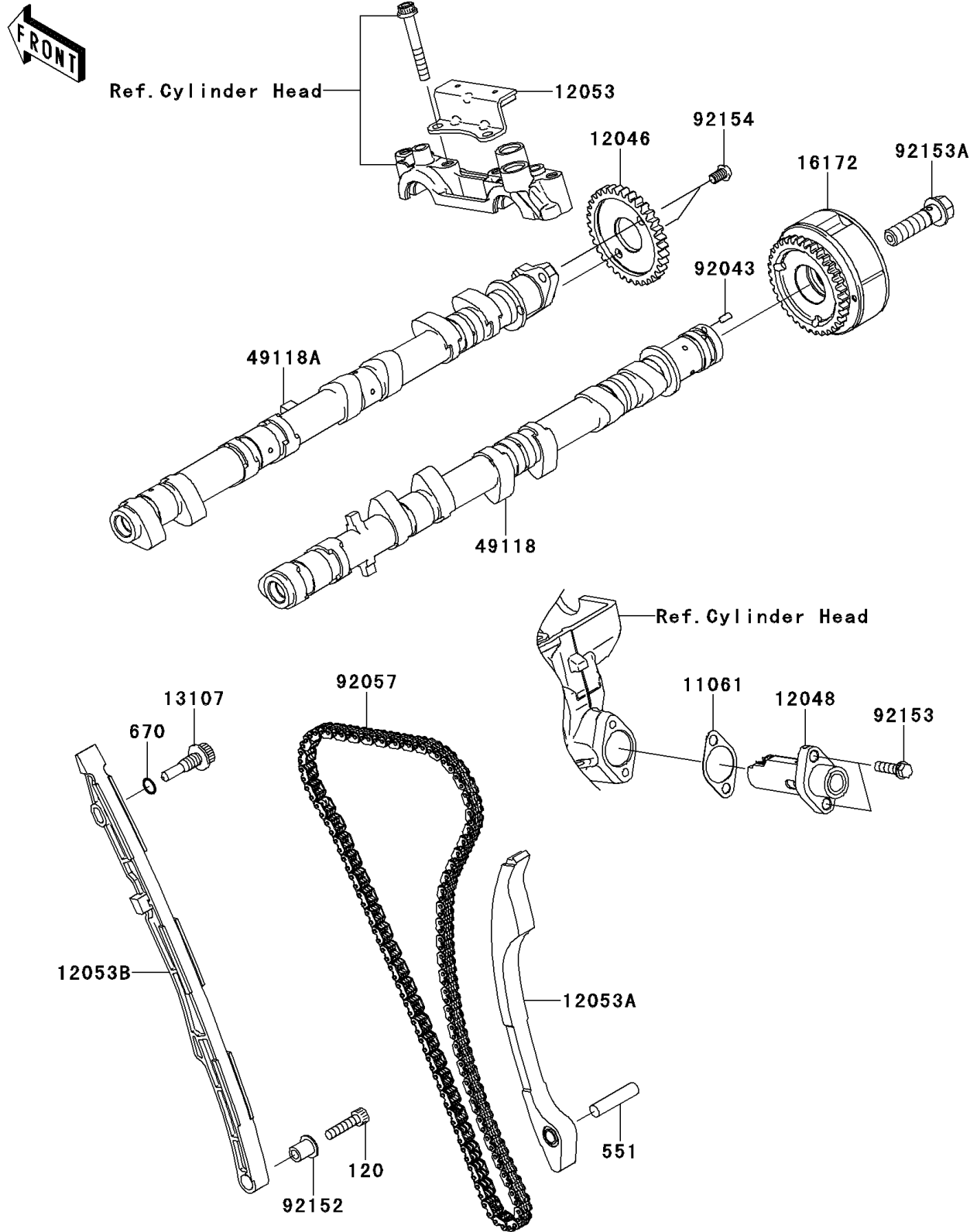

2010 Concours® 14 ABS PARTS LIST

Camshaft(s)/Tensioner

ITEM NAME	PART NUMBER	QUANTITY
BOLT-SOCKET,6X25 (Ref # 120)	120CA0625	1
PIN-DOWEL (Ref # 551)	551A0835	1
O RING,9MM (Ref # 670)	670D1509	1
GASKET,TENSIONER (Ref # 11061)	11061-0299	1
SPROCKET,34T (Ref # 12046)	12046-0085	1
TENSIONER-ASSY,HYDRAULIC (Ref # 12048)	12048-0047	1
GUIDE-CHAIN,UPP (Ref # 12053)	12053-0067	1
GUIDE-CHAIN,RR (Ref # 12053A)	12053-0093	1
GUIDE-CHAIN,FR (Ref # 12053B)	12053-0128	1
SHAFT,CHAIN GUIDE (Ref # 13107)	13107-0157	1
ACTUATOR,VVT (Ref # 16172)	16172-0021	1
CAMSHAFT-COMP,INTAKE (Ref # 49118)	49118-0150	1
CAMSHAFT-COMP,EXHAUST (Ref # 49118A)	49118-0151	1
PIN,3.665X7.8 (Ref # 92043)	92043-0119	1
CHAIN,92RH2015-130M (Ref # 92057)	92057-0109	1
COLLAR (Ref # 92152)	92152-0413	1
BOLT,FLANGED-SMALL,6X22 (Ref # 92153)	92153-1560	1
BOLT,FLANGED,11X40 (Ref # 92153A)	92153-3733	1
BOLT,TORX,6X10 (Ref # 92154)	92154-0062	1