

2012 Brute Force® 750 4x4i EPS PARTS DIAGRAM

Flap

F2173

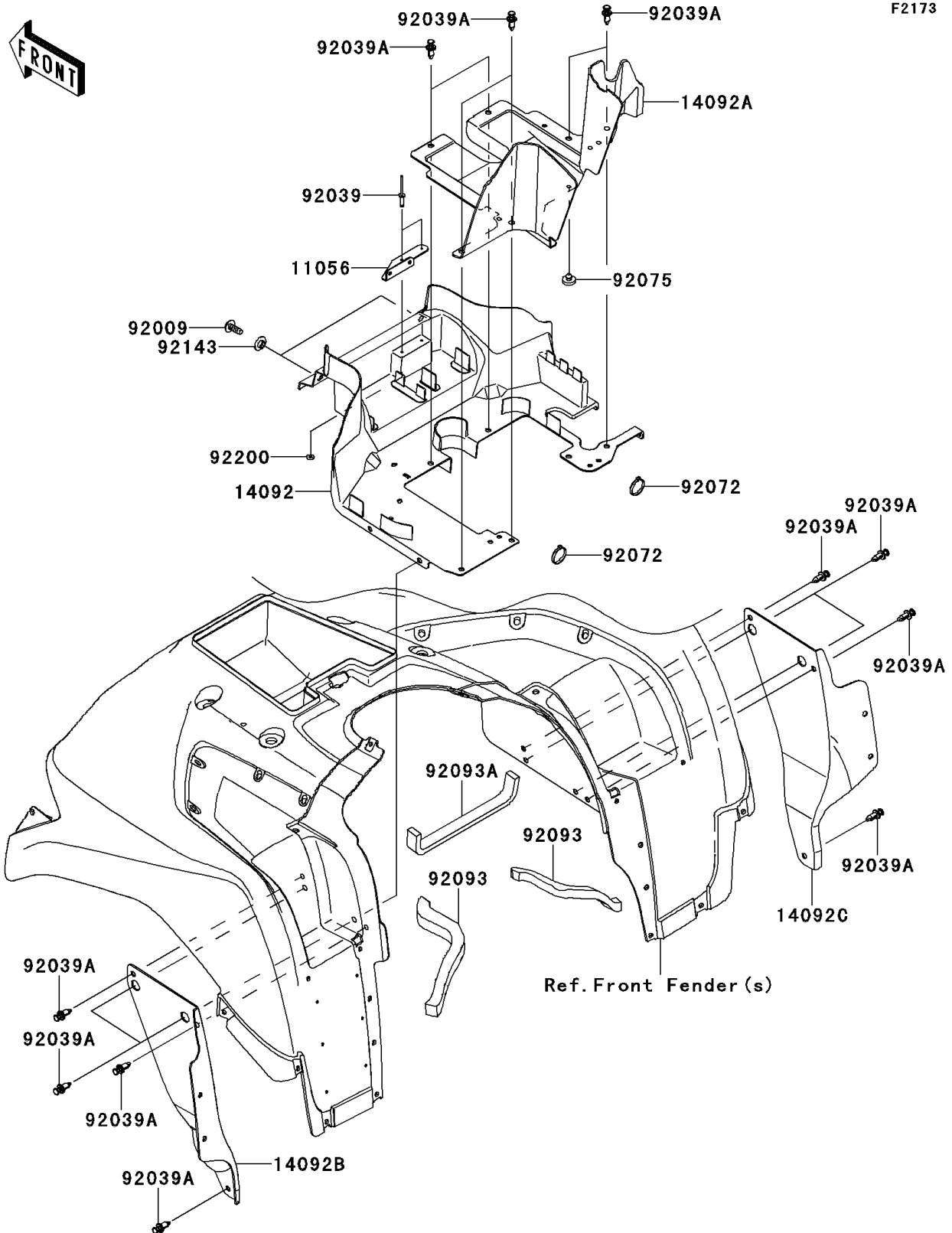

2012 Brute Force® 750 4x4i EPS PARTS LIST

Flap

ITEM NAME	PART NUMBER	QUANTITY
BRACKET,V.D. SENSOR (Ref # 11056)	11056-0956	1
COVER, TOP INNER,FR (Ref # 14092)	14092-0181	1
COVER, TOP INNER,RR (Ref # 14092A)	14092-0182	1
COVER, SIDE INNER,LH (Ref # 14092B)	14092-0183	1
COVER, SIDE INNER,RH (Ref # 14092C)	14092-0184	1
SCREW, TAPPING,6X16 (Ref # 92009)	92009-1166	1
RIVET (Ref # 92039)	92039-0031	1
RIVET (Ref # 92039A)	92039-1229	1
BAND,L=292.1 (Ref # 92072)	92072-3509	1
DAMPER,BOOST SENSOR (Ref # 92075)	92075-2113	1
SEAL,20X270X30 (Ref # 92093)	92093-0570	1
SEAL,20X300X20 (Ref # 92093A)	92093-0571	1
COLLAR (Ref # 92143)	92143-1087	1
WASHER,3.5X8X1 (Ref # 92200)	92200-1251	1