

2008 KX™250F PARTS DIAGRAM

Crankcase

E1411

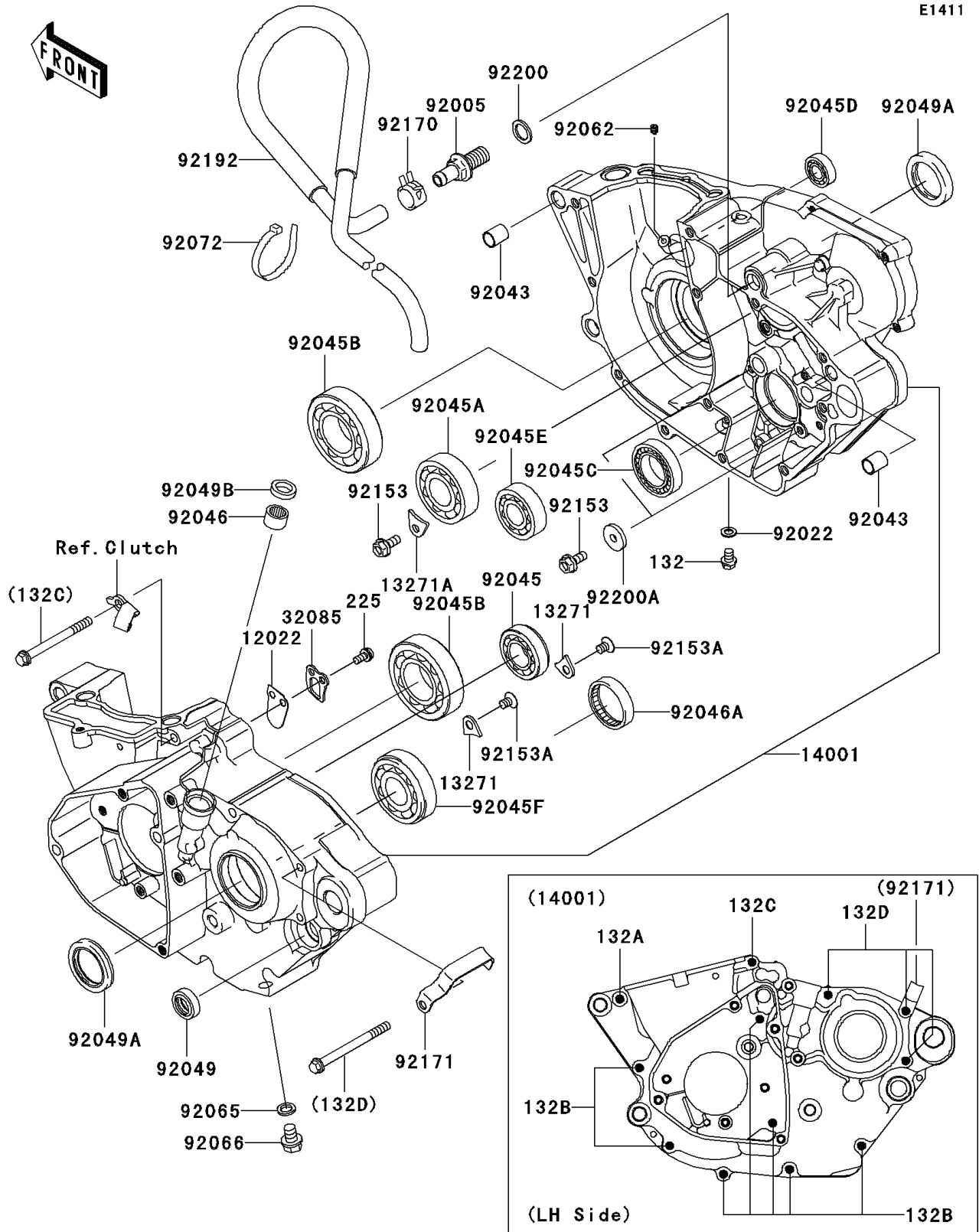

2008 KX™250F PARTS LIST

Crankcase

ITEM NAME	PART NUMBER	QUANTITY
BOLT-FLANGED-SMALL,6X8 (Ref # 132)	132G0608	1
BOLT-FLANGED-SMALL,6X40 (Ref # 132A)	132G0640	1
BOLT-FLANGED-SMALL,6X60 (Ref # 132B)	132G0660	1
BOLT-FLANGED-SMALL,6X65 (Ref # 132C)	132G0665	1
BOLT-FLANGED-SMALL,6X70 (Ref # 132D)	132G0670	1
SCREW-PAN-WSP-CROS,5X10 (Ref # 225)	225D0510	1
VALVE-REED (Ref # 12022)	12022-0006	1
PLATE (Ref # 13271)	13271-0886	1
PLATE (Ref # 13271A)	13271-0887	1
SET-CRANKCASE (Ref # 14001)	14001-0123	1
STOPPER,VALVE-REED (Ref # 32085)	32085-0011	1
FITTING,BREATHER (Ref # 92005)	92005-0014	1
WASHER,6.2X11X1 (Ref # 92022)	92022-304	1
PIN,10.1X12X14 (Ref # 92043)	92043-4009	1
BEARING-BALL,3TM-SX0391ZC3 (Ref # 92045)	92045-0013	1
BEARING-BALL,22X50X14 (Ref # 92045A)	92045-0051	1
BEARING-BALL,CRANKSHAFT MAIN (Ref # 92045B)	92045-0052	1
BEARING-BALL,6905Z (Ref # 92045C)	92045-1058	1
BEARING-BALL,#628 (Ref # 92045D)	92045-1123	1
BEARING-BALL,TMB203 (Ref # 92045E)	92045-1291	1
BEARING-BALL,SX04A81C3 (Ref # 92045F)	92045-1335	1
BEARING-NEEDLE,HK1210 (Ref # 92046)	92046-1010	1
BEARING-NEEDLE,7E-HKS33X38X8 (Ref # 92046A)	92046-1221	1
SEAL-OIL,SD2 14 22 6-1 NS (Ref # 92049)	92049-0015	1
SEAL-OIL,TC 30 40 7 (Ref # 92049A)	92049-0030	1
SEAL-OIL,AG0353-F0 (Ref # 92049B)	92049-1262	1
NOZZLE (Ref # 92062)	92062-0004	1
GASKET,10.5X16X1 (Ref # 92065)	92065-058	1
PLUG,DRAIN (Ref # 92066)	92066-1437	1

2008 KX™250F PARTS LIST

Crankcase

ITEM NAME	PART NUMBER	QUANTITY
BAND (Ref # 92072)	92072-3874	1
BOLT,6X14 (Ref # 92153)	92153-0878	1
BOLT,TORX,6X6.7 (Ref # 92153A)	92153-1736	1
CLAMP (Ref # 92170)	92170-1938	1
CLAMP (Ref # 92171)	92171-0579	1
TUBE,BREATHER (Ref # 92192)	92192-0102	1
WASHER,12.5X18X1.6 (Ref # 92200)	92200-0087	1
WASHER,6X20X3.2 (Ref # 92200A)	92200-0120	1