

2015 NINJA® ZX™10R ABS PARTS DIAGRAM

Oil Pan

E1434

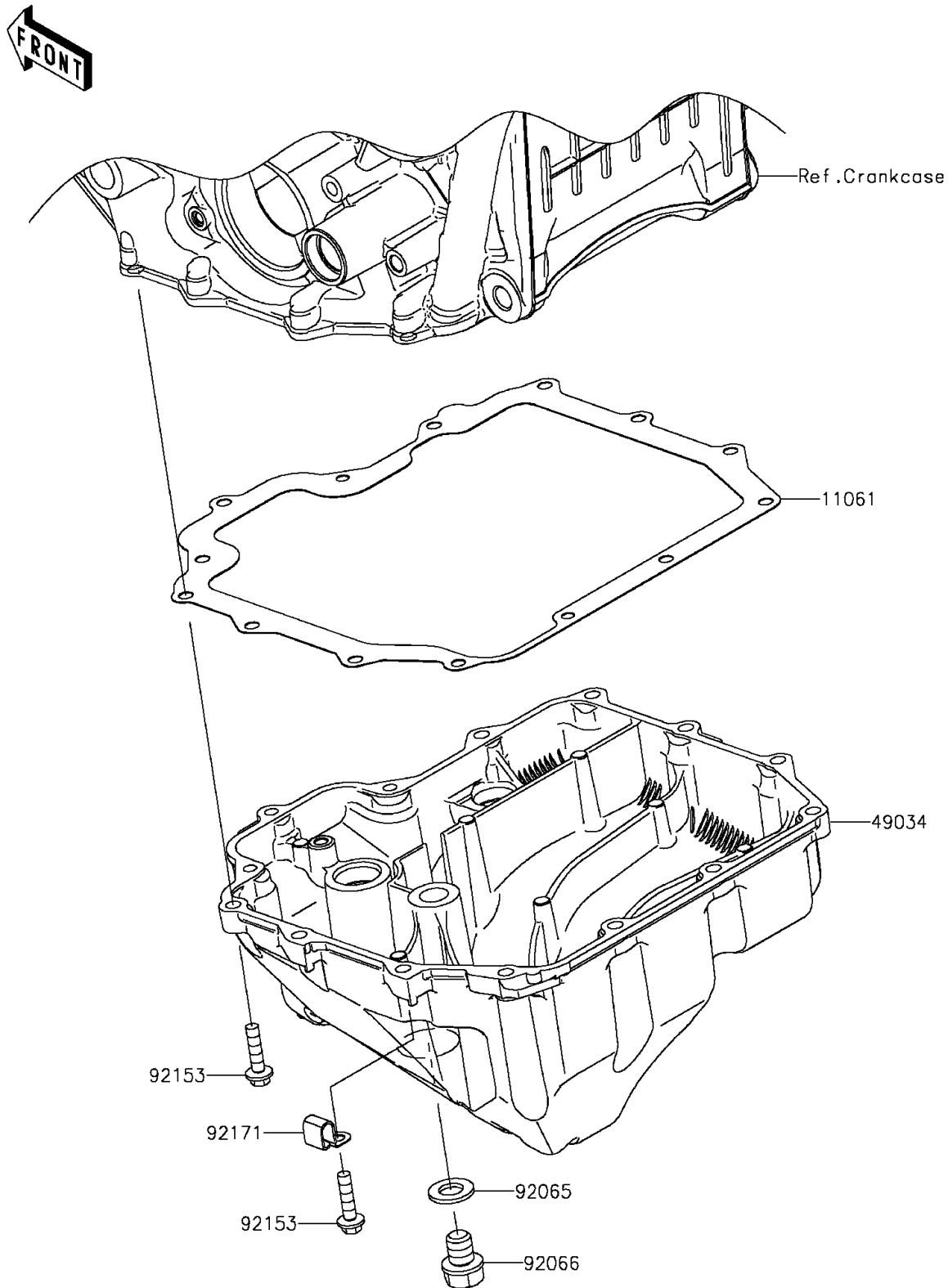

2015 NINJA® ZX™10R ABS PARTS LIST

Oil Pan

ITEM NAME	PART NUMBER	QUANTITY
GASKET,OIL PAN (Ref # 11061)	11061-0747	1
PAN-OIL (Ref # 49034)	49034-0038	1
GASKET,12X22X2 (Ref # 92065)	92065-097	1
PLUG,12X15 (Ref # 92066)	92066-0079	1
BOLT,FLANGED,6X25 (Ref # 92153)	92153-1569	1
CLAMP (Ref # 92171)	92171-0534	1