

2009 Vulcan® 1700 Nomad™ PARTS DIAGRAM

Fuel Evaporative System(CA)

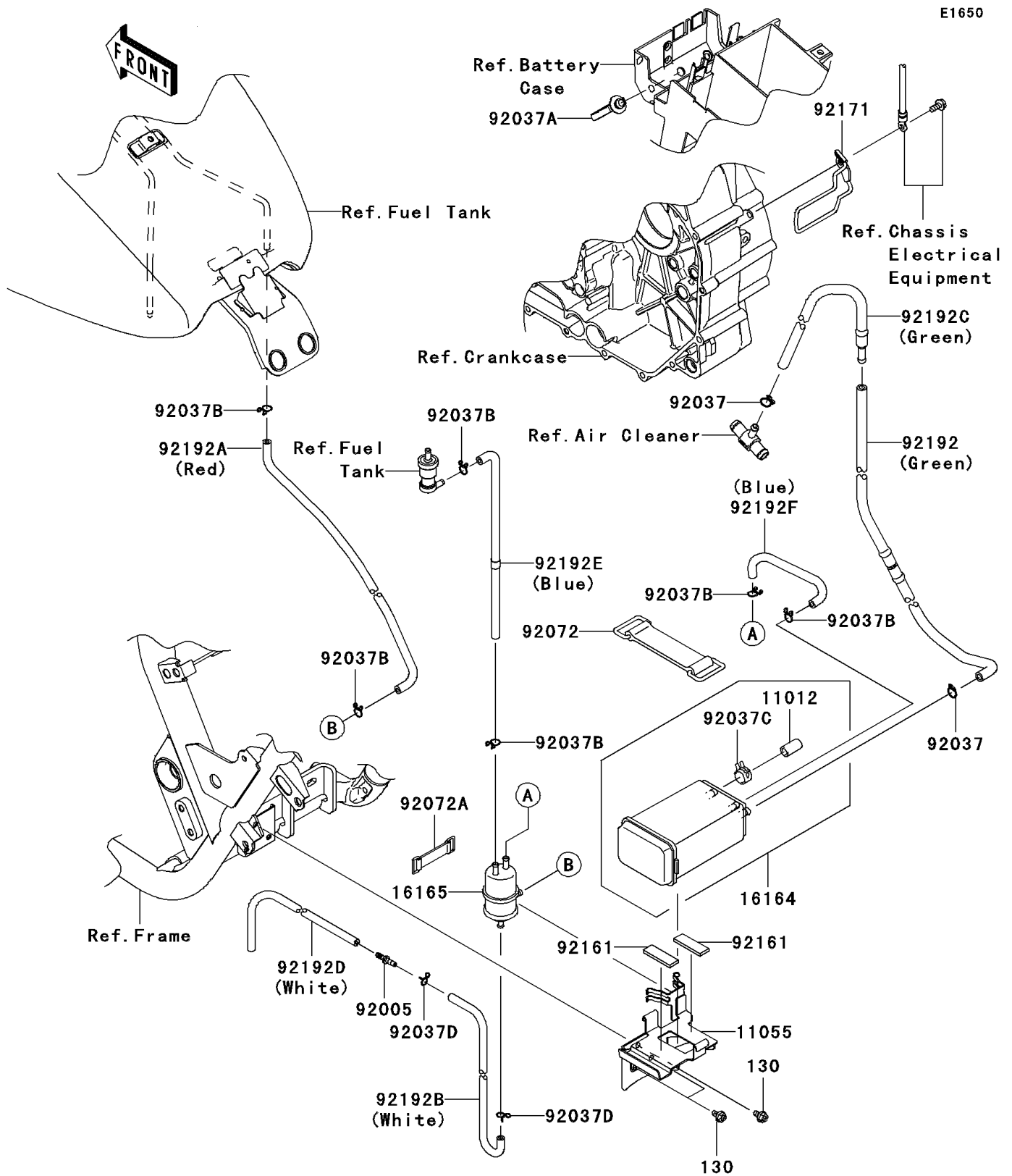

2009 Vulcan® 1700 Nomad™ PARTS LIST

Fuel Evaporative System(CA)

ITEM NAME	PART NUMBER	QUANTITY
BOLT-FLANGED,6X10 (Ref # 130)	130BB0610	1
CAP,CANISTER (Ref # 11012)	11012-1388	1
BRACKET (Ref # 11055)	11055-1653	1
CANISTER (Ref # 16164)	16164-1054	1
SEPARATOR (Ref # 16165)	16165-1001	1
FITTING (Ref # 92005)	92005-1206	1
CLAMP,HOSE (Ref # 92037)	92037-1104	1
CLAMP,CABLE (Ref # 92037A)	92037-1459	1
CLAMP,TUBE (Ref # 92037B)	92037-147	1
CLAMP,CANISTER (Ref # 92037C)	92037-1512	1
CLAMP (Ref # 92037D)	92037-1712	1
BAND (Ref # 92072)	92072-1384	1
BAND,L=50 (Ref # 92072A)	92072-1419	1
DAMPER (Ref # 92161)	92161-0124	1
CLAMP (Ref # 92171)	92171-1798	1
TUBE,CANISTER-1ST FTG,GREEN (Ref # 92192)	92192-0657	1
TUBE,SEPARATOR-TANK,RED (Ref # 92192A)	92192-0660	1
TUBE,FITTING-SEP.WHITE (Ref # 92192B)	92192-0692	1
TUBE,1ST FTG-2ND FTG,GREEN (Ref # 92192C)	92192-0760	1
TUBE,THROBO-FITTING,WHITE (Ref # 92192D)	92192-0761	1
TUBE,CHECKVALVE-SEP.,BLUE (Ref # 92192E)	92192-0809	1
TUBE,CANISTER-SEPARATOR,BLUE (Ref # 92192F)	92192-0824	1