

2009 Vulcan® 1700 Nomad™ PARTS DIAGRAM

Left Engine Cover(s)

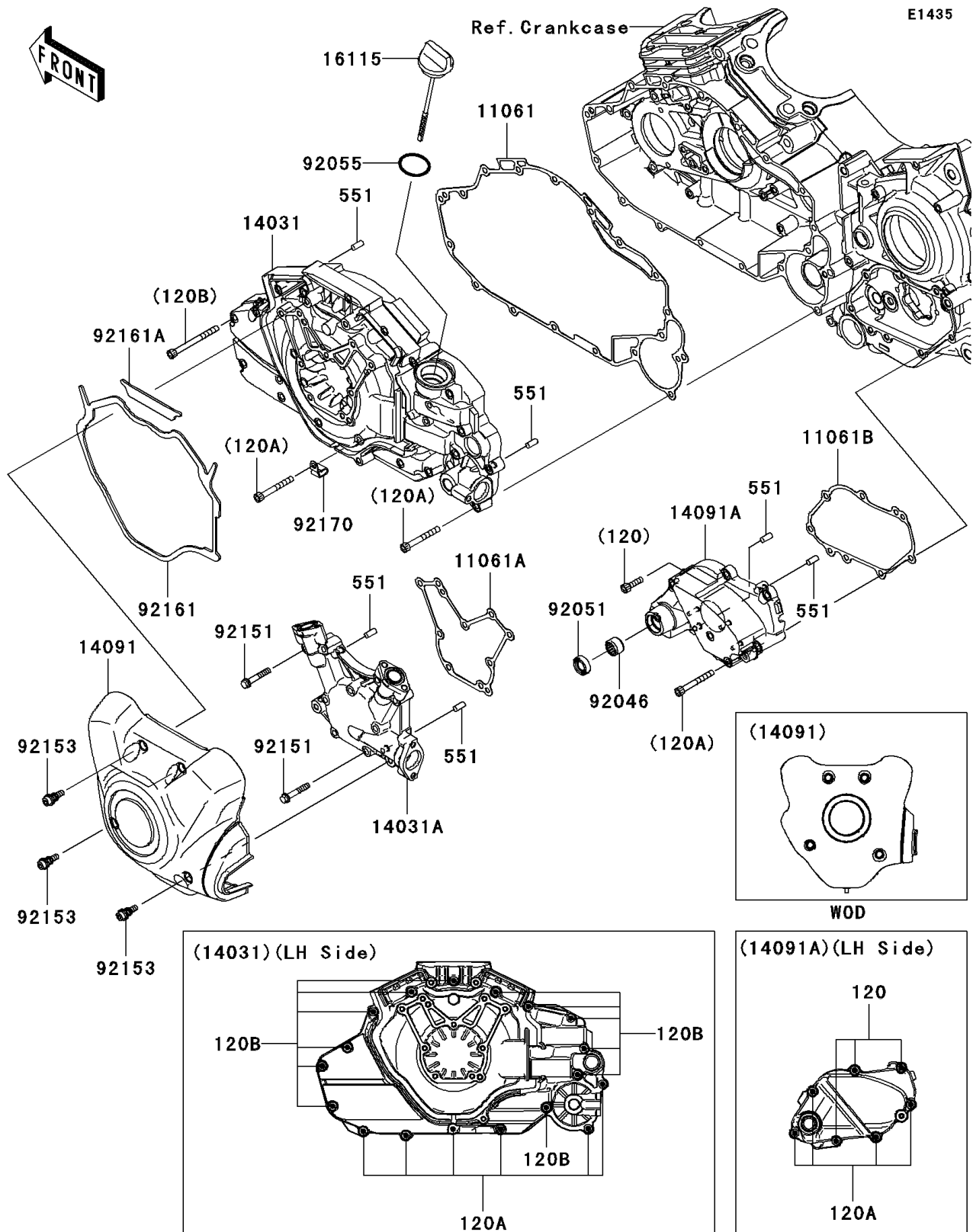

2009 Vulcan® 1700 Nomad™ PARTS LIST

Left Engine Cover(s)

ITEM NAME	PART NUMBER	QUANTITY
BOLT-SOCKET,6X22 (Ref # 120)	120CC0622	1
BOLT-SOCKET,6X50 (Ref # 120A)	120CC0650	1
BOLT-SOCKET,6X70 (Ref # 120B)	120CC0670	1
PIN-DOWEL,6X14 (Ref # 551)	551A0614	1
GASKET,GENERATOR COVER,IN (Ref # 11061)	11061-0338	1
GASKET,GENERATOR COVER,MID (Ref # 11061A)	11061-0339	1
GASKET,CHANGE COVER (Ref # 11061B)	11061-0340	1
COVER-GENERATOR,INNER (Ref # 14031)	14031-0093	1
COVER-GENERATOR,MIDDLE (Ref # 14031A)	14031-0094	1
COVER,GENERATOR,OUTER (Ref # 14091)	14091-1690	1
COVER,CHANGE (Ref # 14091A)	14091-1807	1
CAP-OIL FILLER (Ref # 16115)	16115-0019	1
BEARING-NEEDLE,HK1312 (Ref # 92046)	92046-1148	1
SEAL-OIL,TB13225.5 (Ref # 92051)	92051-005	1
RING-O,31.5X2.6 (Ref # 92055)	92055-049	1
BOLT,6X35 (Ref # 92151)	92151-1624	1
BOLT,SOCKET,6X22 (Ref # 92153)	92153-1331	1
DAMPER (Ref # 92161)	92161-0668	1
DAMPER (Ref # 92161A)	92161-0672	1
CLAMP (Ref # 92170)	92170-1577	1