

2006 Eliminator® 125 PARTS DIAGRAM

Frame Fittings

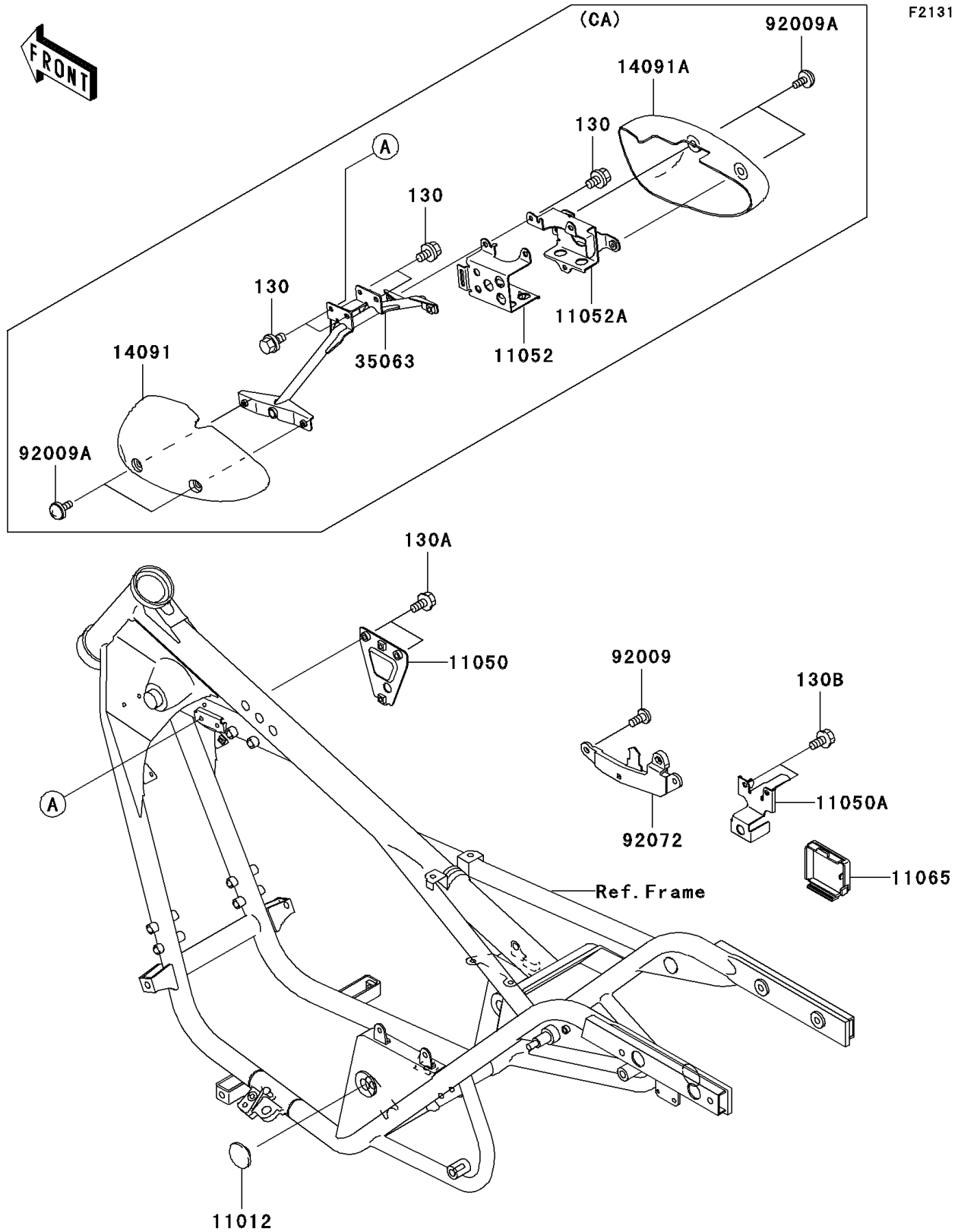

2006 Eliminator® 125 PARTS LIST

Frame Fittings

ITEM NAME	PART NUMBER	QUANTITY
BOLT-FLANGED,6X12 (Ref # 130A)	130BB0612	1
BOLT-FLANGED,6X16 (Ref # 130B)	130BB0616	1
CAP,PIVOT (Ref # 11012)	11012-1821	1
BRACKET,IGNITER (Ref # 11050)	11050-1383	1
BRACKET,ELECTRIC (Ref # 11050A)	11050-1526	1
CAP,TOOL CASE (Ref # 11065)	11065-1068	1
SCREW,6X16 (Ref # 92009)	92009-1621	1
BAND (Ref # 92072)	92072-1348	1
BOLT-FLANGED,6X10 (Ref # 130)	130BB0610	1
BRACKET,CANISTER-IN (Ref # 11052)	11052-1314	1
BRACKET,CANISTER-OUT (Ref # 11052A)	11052-1315	1
COVER,EVAPO,LH (Ref # 14091)	14091-1374	1
COVER,EVAPO,RH (Ref # 14091A)	14091-1375	1
STAY,EVAPO (Ref # 35063)	35063-1176	1
SCREW,6X10 (Ref # 92009A)	92009-1716	1