

2006 Eliminator® 125 PARTS DIAGRAM

Oil Pump/Oil Filter

E1710

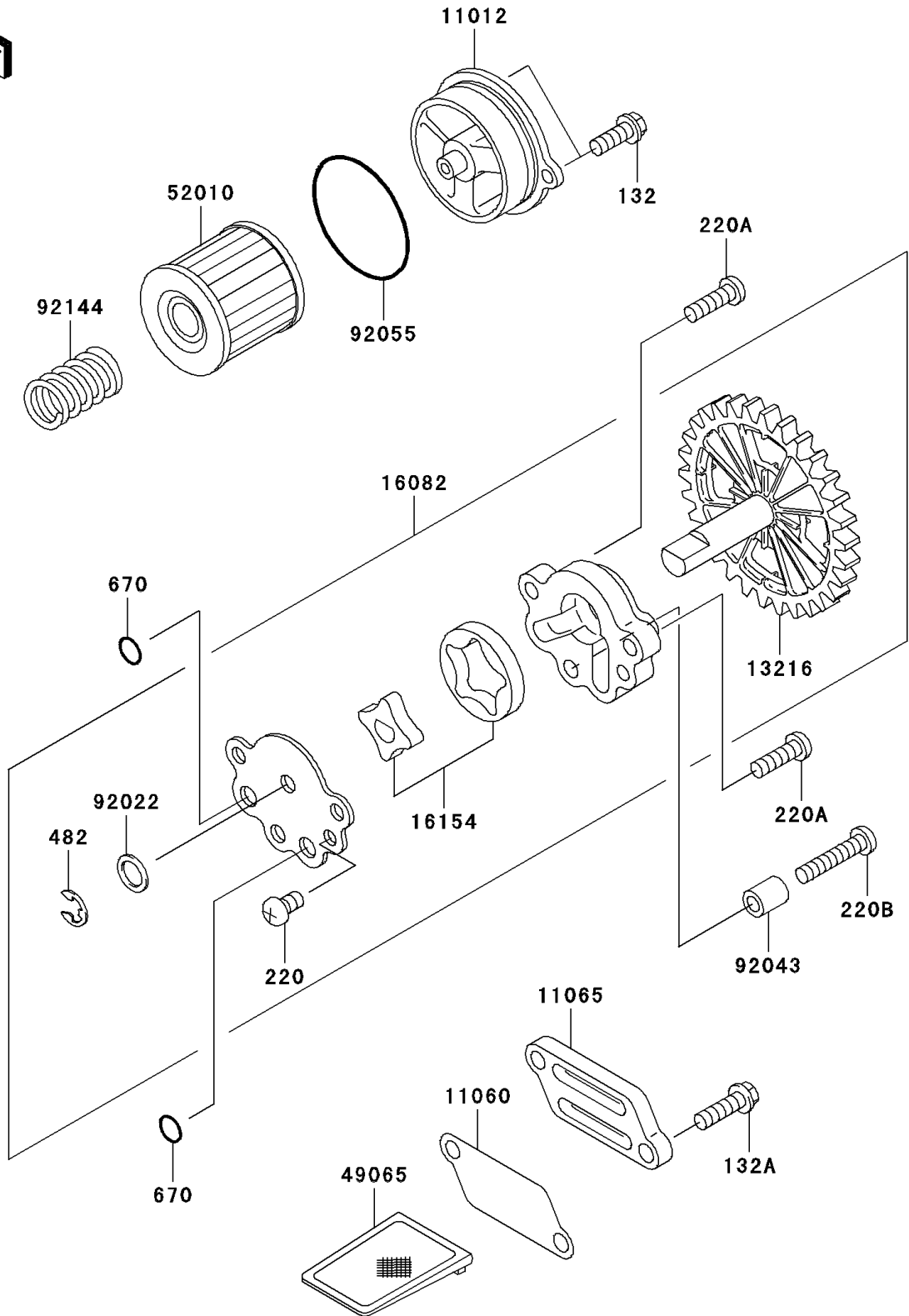

2006 Eliminator® 125 PARTS LIST

Oil Pump/Oil Filter

ITEM NAME	PART NUMBER	QUANTITY
BOLT-FLANGED-SMALL,6X16 (Ref # 132)	132BA0616	1
BOLT-FLANGED-SMALL,6X20 (Ref # 132A)	132BA0620	1
SCREW-PAN-CROSS,6X10 (Ref # 220)	220AA0610	1
SCREW-PAN-CROS,6X20 (Ref # 220A)	220AA0620	1
SCREW-PAN-CROSS,6X30 (Ref # 220B)	220AA0630	1
CIRCLIP-TYPE-E,6MM (Ref # 482)	482J6000	1
O RING,10MM (Ref # 670)	670B1510	1
CAP (Ref # 11012)	11012-1971	1
GASKET,OIL FILTER (Ref # 11060)	11060-1768	1
CAP,OIL FILTER (Ref # 11065)	11065-0114	1
GEAR-COMP,OIL PUMP (Ref # 13216)	13216-1167	1
PUMP-ASSY-OIL (Ref # 16082)	16082-1153	1
ROTOR-PUMP (Ref # 16154)	16154-1077	1
FILTER-OIL (Ref # 49065)	49065-1075	1
ELEMENT-OIL FILTER (Ref # 52010)	52010-1053	1
WASHER,10.2X14.5X1.0 (Ref # 92022)	92022-1181	1
PIN,6.2X8X14 (Ref # 92043)	92043-1263	1
RING-O,52.6X2.4 (Ref # 92055)	92055-1577	1
SPRING (Ref # 92144)	92144-1761	1