

1994 NINJA® ZX™-9R PARTS DIAGRAM

Gear Change Mechanism

E1370

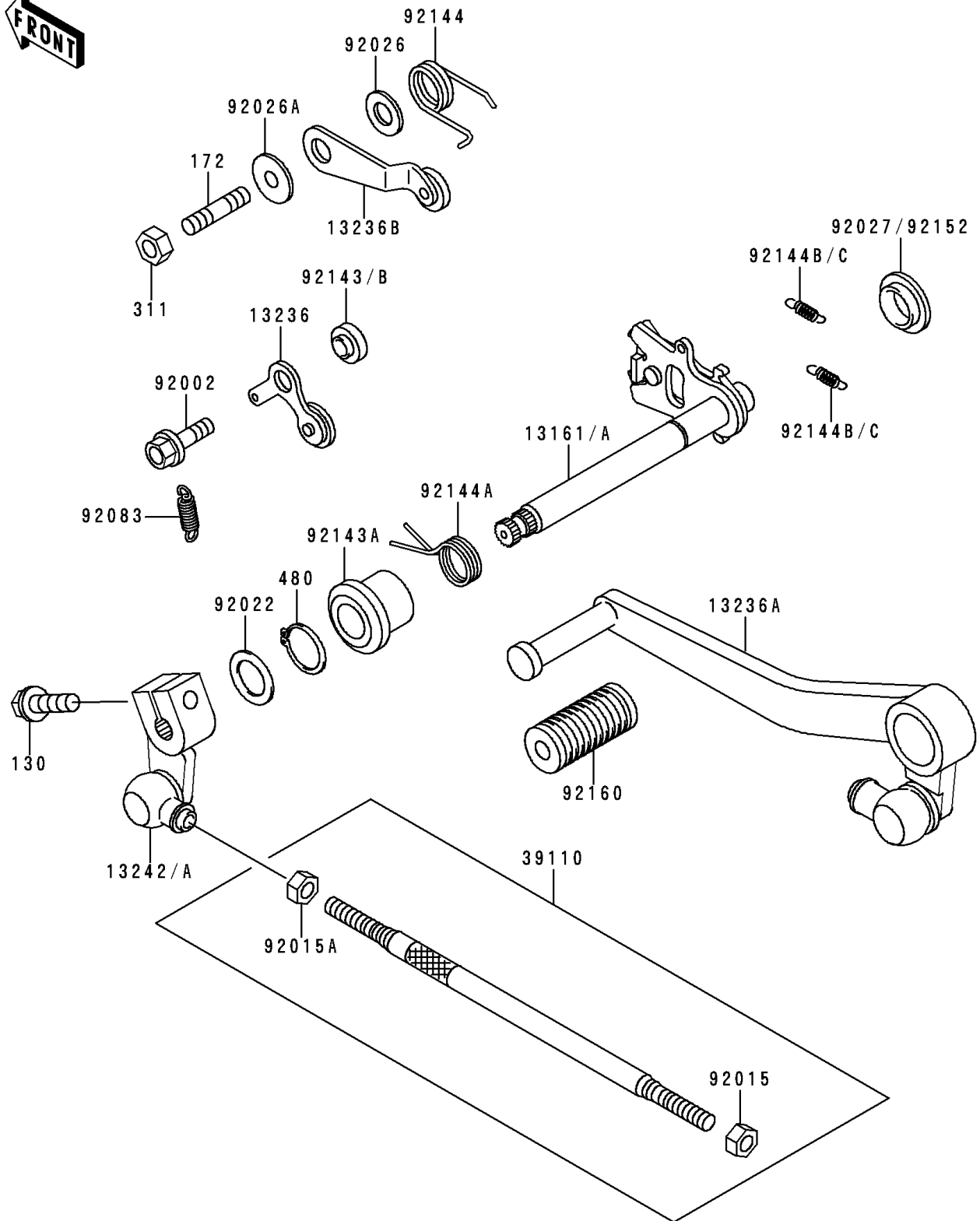

1994 NINJA® ZX™-9R PARTS LIST

Gear Change Mechanism

ITEM NAME	PART NUMBER	QUANTITY
BOLT-FLANGED,6X20,BLACK (Ref # 130)	130S0620	1
BOLT-STUD,6X14 (Ref # 172)	172G0614	1
NUT-HEX,6MM (Ref # 311)	311G0600	1
CIRCLIP-TYPE-C,13MM (Ref # 480)	480J1300	1
LEVER-COMP-CHANGE SHAFT (Ref # 13161A)	13161-1204	1
LEVER-COMP,POSITION (Ref # 13236)	13236-1189	1
LEVER-COMP,CHANGE PEDAL (Ref # 13236A)	13236-1254	1
LEVER-COMP,NEUTRAL POSITION (Ref # 13236B)	13236-1255	1
LEVER-ASSY-CHANGE (Ref # 13242)	13242-1194	1
ROD-ASSY-TIE (Ref # 39110)	39110-1105	1
BOLT,6X16 (Ref # 92002)	92002-1571	1
NUT,LH,THREAD (Ref # 92015)	92015-1443	1
NUT,RH,THREAD (Ref # 92015A)	92015-1444	1
WASHER,13.3X20X1 (Ref # 92022)	92022-1496	1
SPACER,6.3X12X1.0 (Ref # 92026)	92026-094	1
SPACER (Ref # 92026A)	92026-1217	1
COLLAR,CHANGE SHAFT,L=5.5 (Ref # 92027)	92027-1512	1
SPRING,CHANGE DRUM LEVER (Ref # 92083)	92083-012	1
COLLAR,RETURN SPRING (Ref # 92143A)	92143-1498	1
COLLAR (Ref # 92143B)	92143-1678	1
SPRING,NEUTRAL POSITION (Ref # 92144)	92144-1030	1
SPRING,CHANGE SHAFT RETURN (Ref # 92144A)	92144-1628	1
SPRING,CHANGE LEVER (Ref # 92144B)	92144-1776	1
DAMPER,CHANGE PEDAL (Ref # 92160)	92160-1036	1