

1990 NINJA® ZX™-7 PARTS DIAGRAM

Seat

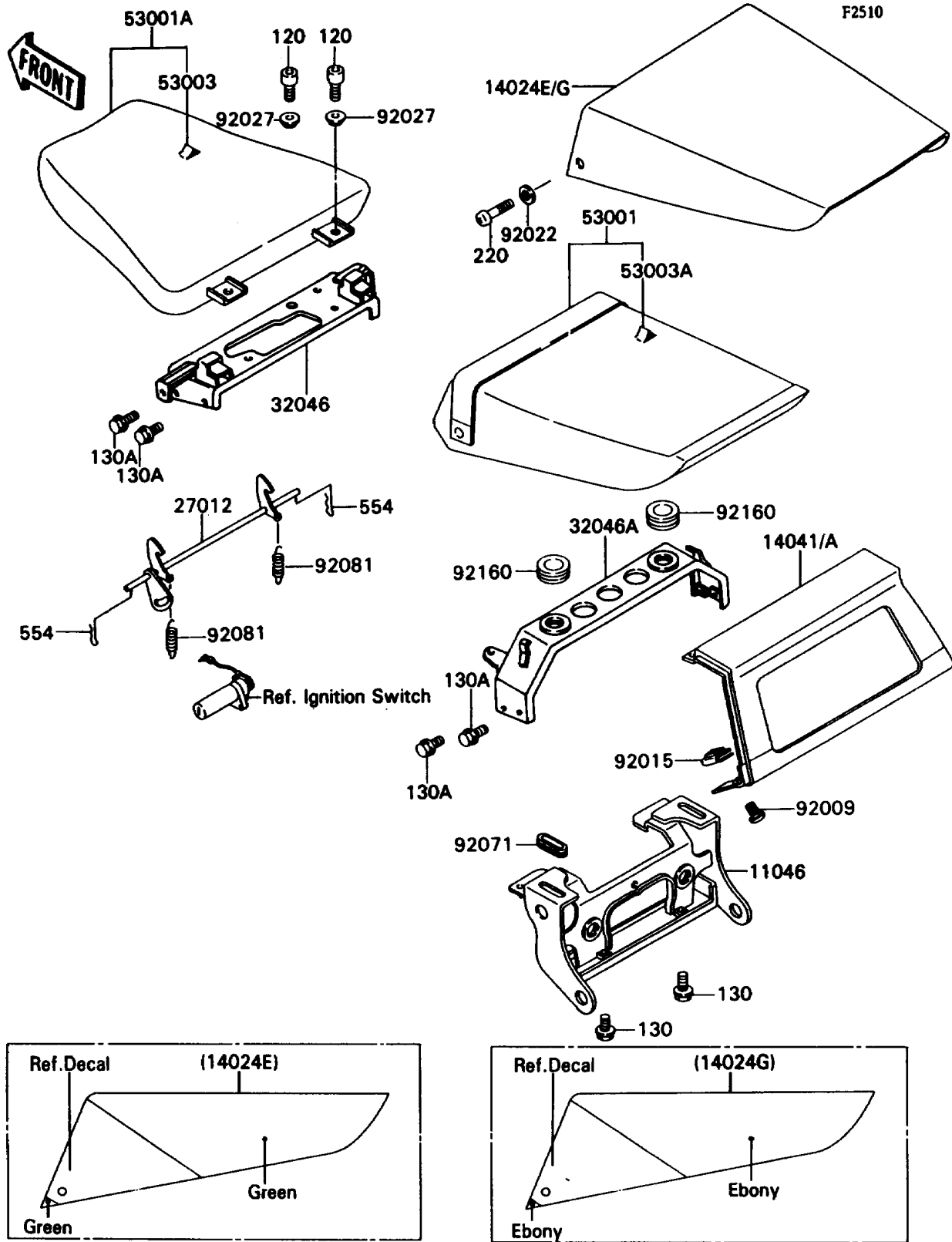

1990 NINJA® ZX™-7 PARTS LIST

Seat

ITEM NAME	PART NUMBER	QUANTITY
BRACKET,SEAT COVER (Ref # 11046)	11046-1539	1
COVER,SINGLE SEAT,L.GREEN (Ref # 14024E)	14024-5175-7F	1
COVER,SINGLE SEAT,EBONY (Ref # 14024G)	14024-5186-H8	1
COVER-COMP,SEAT,EBONY (Ref # 14041)	14041-1094-H8	1
COVER-COMP,SEAT,L.GREEN (Ref # 14041A)	14041-1094-7F	1
HOOK,SEAT (Ref # 27012)	27012-1400	1
BRACKET-SEAT,CNT (Ref # 32046)	32046-1345	1
BRACKET-SEAT,RR (Ref # 32046A)	32046-1346	1
SEAT-ASSY,RR,W/BAND,BLACK (Ref # 53001)	53001-1574-MA	1
SEAT-ASSY,FR,BLACK (Ref # 53001A)	53001-1618-MA	1
LEATHER,FRONT SEAT,BLACK (Ref # 53003)	53003-1218-MA	1
LEATHER,REAR SEAT,BLACK (Ref # 53003A)	53003-1219-MA	1
SCREW,5X16,BLACK (Ref # 92009)	92009-1301	1
NUT,5MM (Ref # 92015)	92015-1573	1
WASHER,6.2X11X1.5 (Ref # 92022)	92022-183	1
COLLAR,L=6.5 (Ref # 92027)	92027-252	1
GROMMET (Ref # 92071)	92071-1187	1
SPRING,HOOK RETURN (Ref # 92081)	92081-1580	1
DAMPER (Ref # 92160)	92160-1012	1
BOLT-SOCKET,6X16,BLACK (Ref # 120)	120S0616	1
BOLT-FLANGED,6X12 (Ref # 130)	130H0612	1
BOLT-FLANGED,6X14 (Ref # 130A)	130H0614	1
SCREW-PAN-CROS,6X10,BLACK (Ref # 220)	220C0610	1
PIN-SNAP (Ref # 554)	554A0600	1