

1991 NINJA® ZX™-6 PARTS DIAGRAM

Cowling (ZX600-D2/D3)

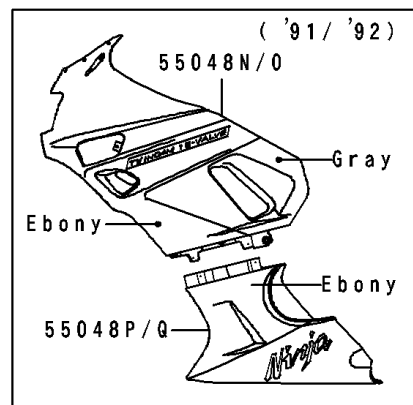
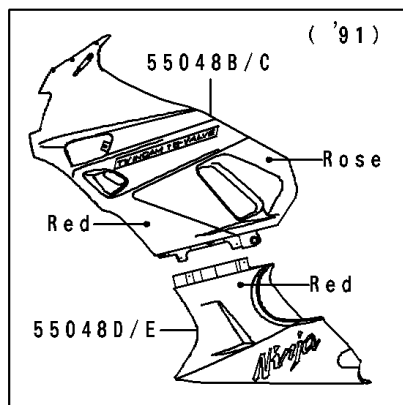
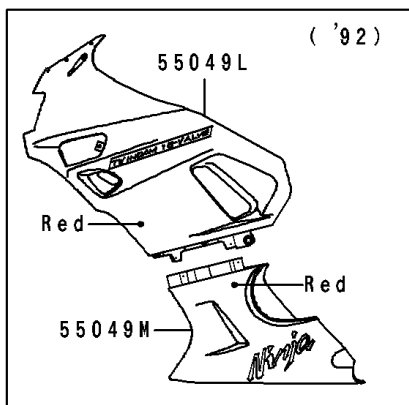
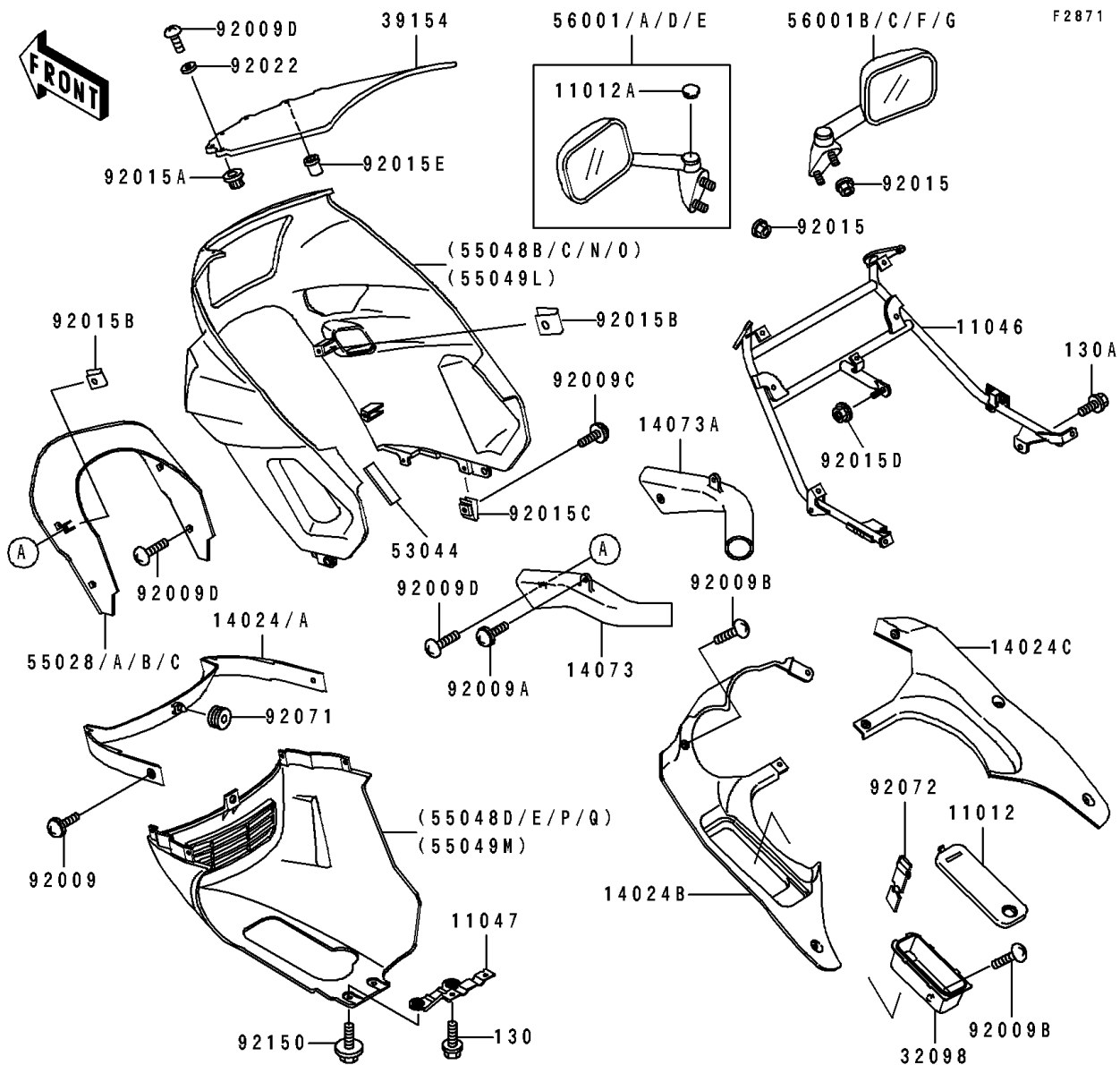

1991 NINJA® ZX™-6 PARTS LIST

Cowling(ZX600-D2/D3)

ITEM NAME	PART NUMBER	QUANTITY
CAP,INNER COWLING,LH (Ref # 11012)	11012-1735	1
CAP,MIRROR,BLACK (Ref # 11012A)	11012-1751-6Z	1
BRACKET,COWLING (Ref # 11046)	11046-1962	1
BRACKET,LWR COWLING (Ref # 11047)	11047-1091	1
COVER,COWLING,CNT,G.GRAY (Ref # 14024)	14024-1877-GD	1
COVER,COWLING,CNT,G.GRAY (Ref # 14024A)	14024-1877-HN	1
COVER,INNER COWLING,LH (Ref # 14024B)	14024-1901	1
COVER,INNER COWLING,RH (Ref # 14024C)	14024-1902	1
DUCT,AIR INTAKE,LH (Ref # 14073)	14073-1426	1
DUCT,AIR INTAKE,RH (Ref # 14073A)	14073-1427	1
CASE-TOOL (Ref # 32098)	32098-1093	1
WINDSHIELD (Ref # 39154)	39154-1109	1
TRIM (Ref # 53044)	53044-1218	1
COWLING,FR,C.C.RED (Ref # 55028)	55028-1244-HR	1
COWLING,FR,EBONY (Ref # 55028A)	55028-1244-H8	1
COWLING,FR,C.C.RED (Ref # 55028B)	55028-1244-L1	1
COWLING.,UPP,RED/ROSE OPERA (Ref # 55048B)	55048-5430-HF	1
COWLING.,UPP,RED/ROSE OPERA (Ref # 55048C)	55048-5430-HP	1
COWLING.,LWR,RED/ROSE OPERA (Ref # 55048D)	55048-5431-HF	1
COWLING.,LWR,RED/ROSE OPERA (Ref # 55048E)	55048-5431-HP	1
COWLING.,UPP,EBONY/GRAY (Ref # 55048N)	55048-5482-JP	1
COWLING.,UPP,EBONY/GRAY (Ref # 55048O)	55048-5482-T4	1
COWLING.,LWR,EBONY/GRAY (Ref # 55048P)	55048-5483-JP	1
COWLING.,LWR,EBONY/GRAY (Ref # 55048Q)	55048-5483-T4	1
MIRROR-ASSY,LH,EBONY (Ref # 56001)	56001-1392-H8	1
MIRROR-ASSY,LH,C.C.RED (Ref # 56001A)	56001-1392-L1	1
MIRROR-ASSY,RH,EBONY (Ref # 56001B)	56001-1393-H8	1
MIRROR-ASSY,RH,C.C.RED (Ref # 56001C)	56001-1393-L1	1
SCREW,6X14,WHITE (Ref # 92009)	92009-1287	1

1991 NINJA® ZX™-6 PARTS LIST

Cowling(ZX600-D2/D3)

ITEM NAME	PART NUMBER	QUANTITY
SCREW,6X14 (Ref # 92009A)	92009-1288	1
SCREW,6X14 (Ref # 92009B)	92009-1611	1
SCREW,6X16 (Ref # 92009C)	92009-1621	1
SCREW,5X16 (Ref # 92009D)	92009-1654	1
NUT,FLANGED,6MM (Ref # 92015)	92015-1233	1
NUT,5MM,COWLING (Ref # 92015A)	92015-1343	1
NUT,5MM (Ref # 92015B)	92015-1573	1
NUT,6MM (Ref # 92015C)	92015-1602	1
NUT,FLANGED,LOCK,8MM (Ref # 92015D)	92015-1696	1
NUT,WELL,5MM (Ref # 92015E)	92015-1757	1
WASHER,NYLON,5.3X11.5X1.5 (Ref # 92022)	92022-1521	1
GROMMET (Ref # 92071)	92071-056	1
BAND,L=300 (Ref # 92072)	92072-1235	1
BOLT,6X14 (Ref # 92150)	92150-1133	1
BOLT-FLANGED (Ref # 130)	130J0612	1
BOLT-FLANGED (Ref # 130A)	130J0812	1