

1991 NINJA® ZX™-6 PARTS DIAGRAM

Turn Signal

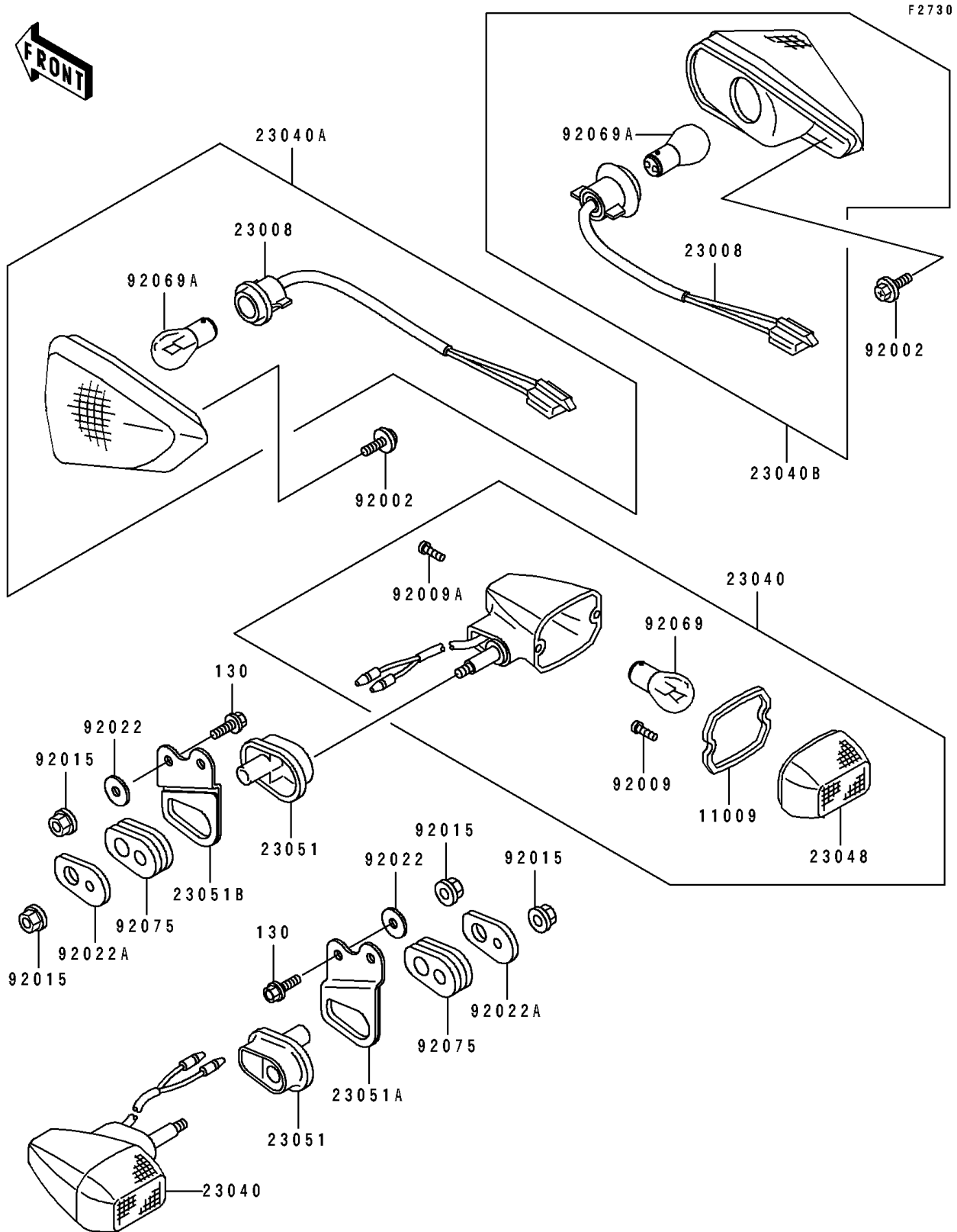

1991 NINJA® ZX™-6 PARTS LIST

Turn Signal

ITEM NAME	PART NUMBER	QUANTITY
GASKET,SIGNAL LAMP (Ref # 11009)	11009-1402	1
SOCKET-ASSY,SIGNAL LAMP,FR (Ref # 23008)	23008-1464	1
LAMP-SIGNAL,RR (Ref # 23040)	23040-1116	1
LAMP-SIGNAL,FR,LH (Ref # 23040A)	23040-1213	1
LAMP-SIGNAL,FR,RH (Ref # 23040B)	23040-1214	1
LENS-SIGNAL LAMP (Ref # 23048)	23048-1054	1
BRACKET-SIGNAL LAMP,RR (Ref # 23051)	23051-1168	1
BRACKET-SIGNAL LAMP,RR,LH (Ref # 23051A)	23051-1211	1
BRACKET-SIGNAL LAMP,RR,RH (Ref # 23051B)	23051-1212	1
BOLT,TAPPING,5X16 (Ref # 92002)	92002-1472	1
SCREW,TAPPING,3X16 (Ref # 92009)	92009-1115	1
SCREW,TAPPING,4X20 (Ref # 92009A)	92009-1304	1
NUT,FLANGED,6MM,BLACK (Ref # 92015)	92015-1237	1
WASHER,6.5X20X1.6,BLACK (Ref # 92022)	92022-1346	1
WASHER,SIGNAL LAMP (Ref # 92022A)	92022-1672	1
BULB,12V 32CP(23W) (Ref # 92069)	92069-055	1
BULB,12V 32/3CP(23/8W) (Ref # 92069A)	92069-060	1
DAMPER,SIGNAL LAMP (Ref # 92075)	92075-1698	1
BOLT-FLANGED,6X16,BLACK (Ref # 130)	130J0616	1