

1996 NINJA® ZX™-11 PARTS DIAGRAM

Handlebar

F2310

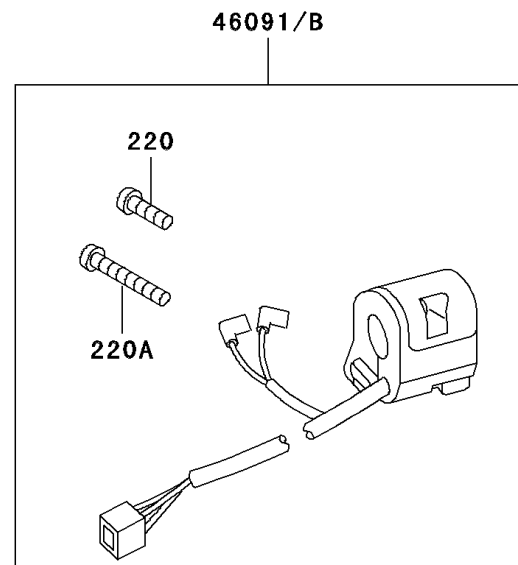
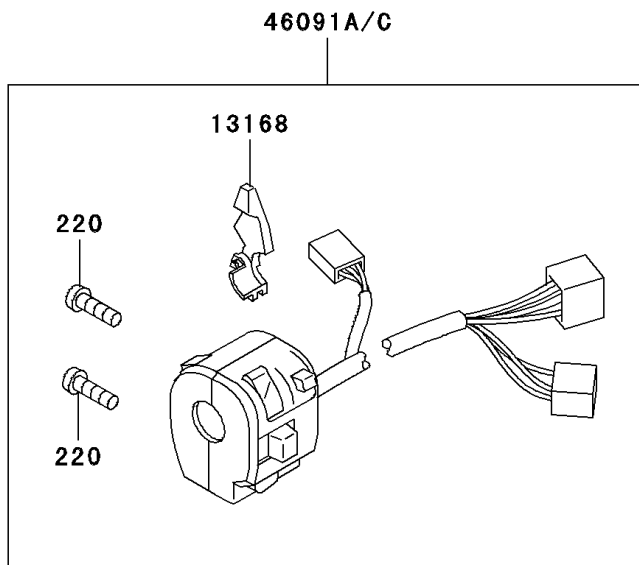
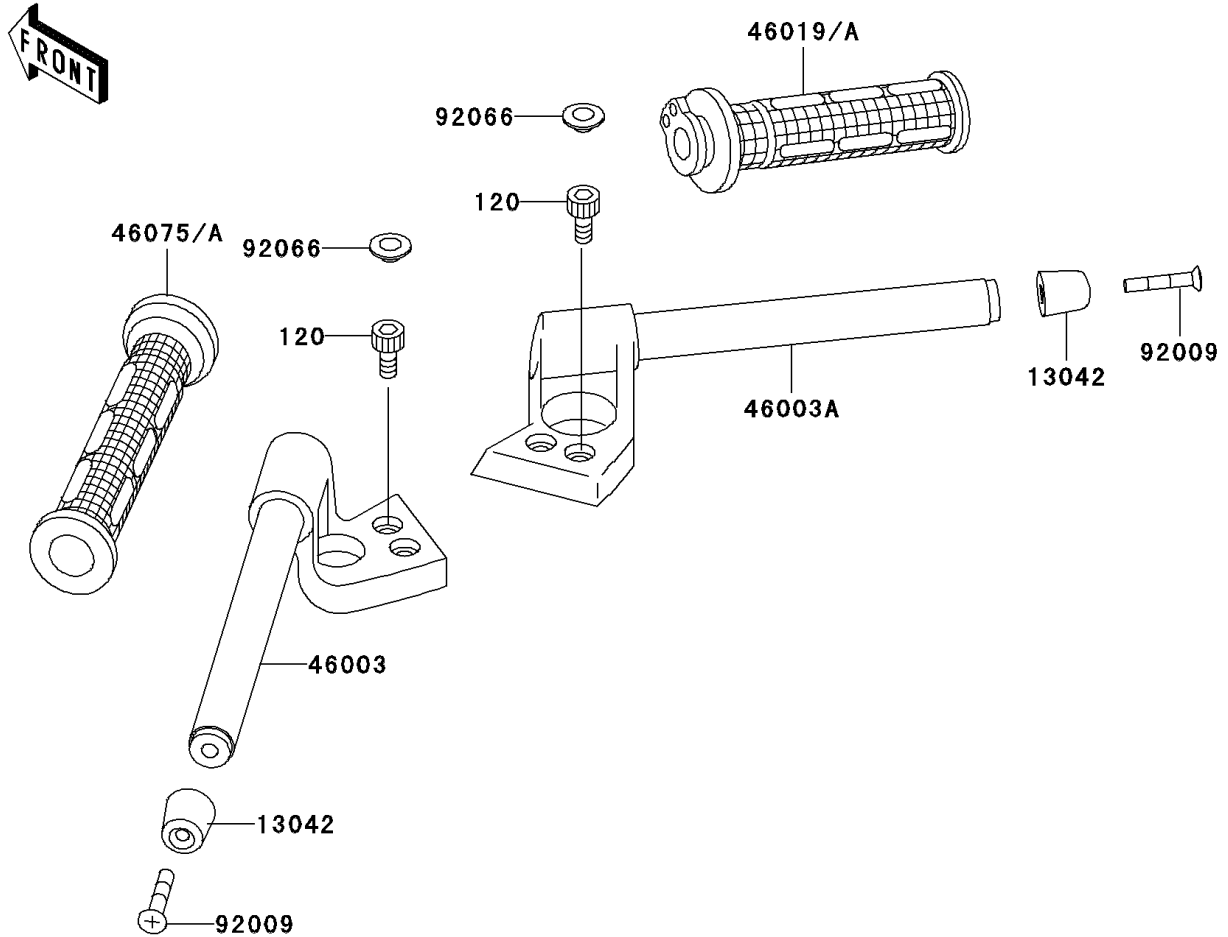

1996 NINJA® ZX™-11 PARTS LIST

Handlebar

ITEM NAME	PART NUMBER	QUANTITY
BOLT-SOCKET,8X25,BLACK (Ref # 120)	120S0825	1
SCREW-PAN-CROS (Ref # 220)	220C0525	1
SCREW-PAN-CROS (Ref # 220A)	220C0540	1
WEIGHT,HANDLE (Ref # 13042)	13042-1005	1
LEVER,CHOKE (Ref # 13168)	13168-1516	1
HANDLE,LH,C.GRAY (Ref # 46003)	46003-1395-EZ	1
HANDLE,RH,C.GRAY (Ref # 46003A)	46003-1396-EZ	1
GRIP-ASSY,THROTTLE (Ref # 46019)	46019-1077	1
GRIP,LH (Ref # 46075)	46075-1088	1
HOUSING-ASSY-CONTROL,RH (Ref # 46091)	46091-1663	1
HOUSING-ASSY-CONTROL,LH (Ref # 46091A)	46091-1665	1
SCREW,8X45 (Ref # 92009)	92009-1257	1
PLUG (Ref # 92066)	92066-1216	1