

1993 NINJA® ZX™-11 PARTS DIAGRAM

Swingarm

F2141

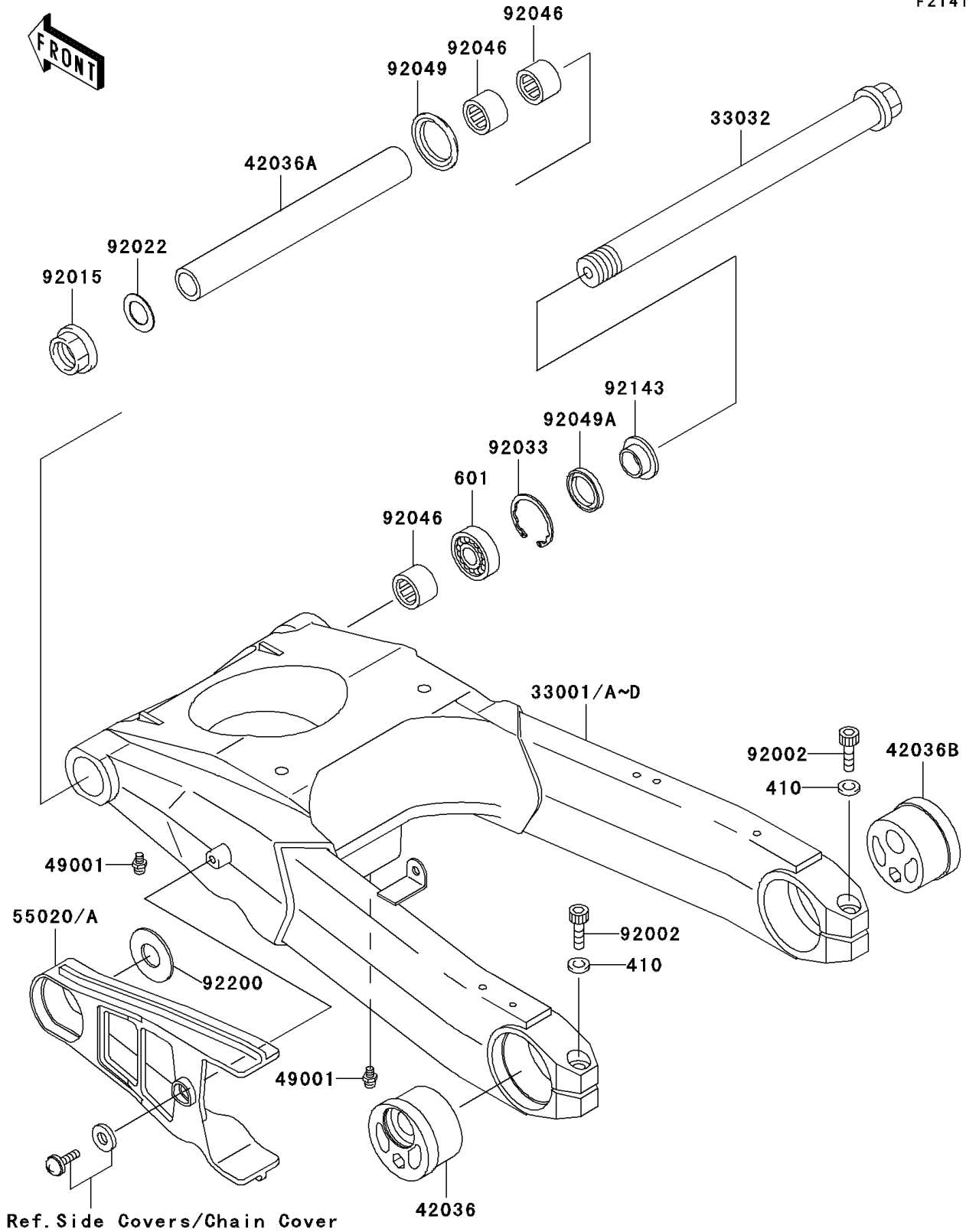

1993 NINJA® ZX™-11 PARTS LIST

Swingarm

ITEM NAME	PART NUMBER	QUANTITY
W-PLAIN-S (Ref # 410)	410E1000	1
BEARING-BALL,#6004 (Ref # 601)	601A6004	1
SHAFT-SWING ARM (Ref # 33032)	33032-1170	1
SLEEVE,REAR AXLE,LH (Ref # 42036)	42036-1153	1
SLEEVE,SWING ARM,L=237 (Ref # 42036A)	42036-1264	1
SLEEVE,REAR AXLE,RH (Ref # 42036B)	42036-1265	1
NIPPLE-GREASE (Ref # 49001)	49001-1051	1
GUARD,CHAIN (Ref # 55020)	55020-1478	1
BOLT,SOCKET,10X40 (Ref # 92002)	92002-1452	1
NUT,FLANGED,20MM (Ref # 92015)	92015-1724	1
WASHER,THRUST,20.5MM (Ref # 92022)	92022-1280	1
RING-SNAP,42MM (Ref # 92033)	92033-1041	1
BEARING-NEEDLE,BM283417 (Ref # 92046)	92046-1111	1
SEAL-OIL (Ref # 92049)	92049-1181	1
SEAL-OIL,MHSA25 42 6 (Ref # 92049A)	92049-1314	1
COLLAR,SWING ARM,L=12.5 (Ref # 92143)	92143-1227	1
WASHER,20.3X48X2.3 (Ref # 92200)	92200-1167	1
ARM-COMP-SWING,SILVER NO.35 (Ref # 33001A)	33001-1417-TX	1
ARM-COMP-SWING,SILVER NO.35 (Ref # 33001B)	33001-1417-VZ	1