

1990 NINJA® ZX™-11 PARTS DIAGRAM

Frame

F2120

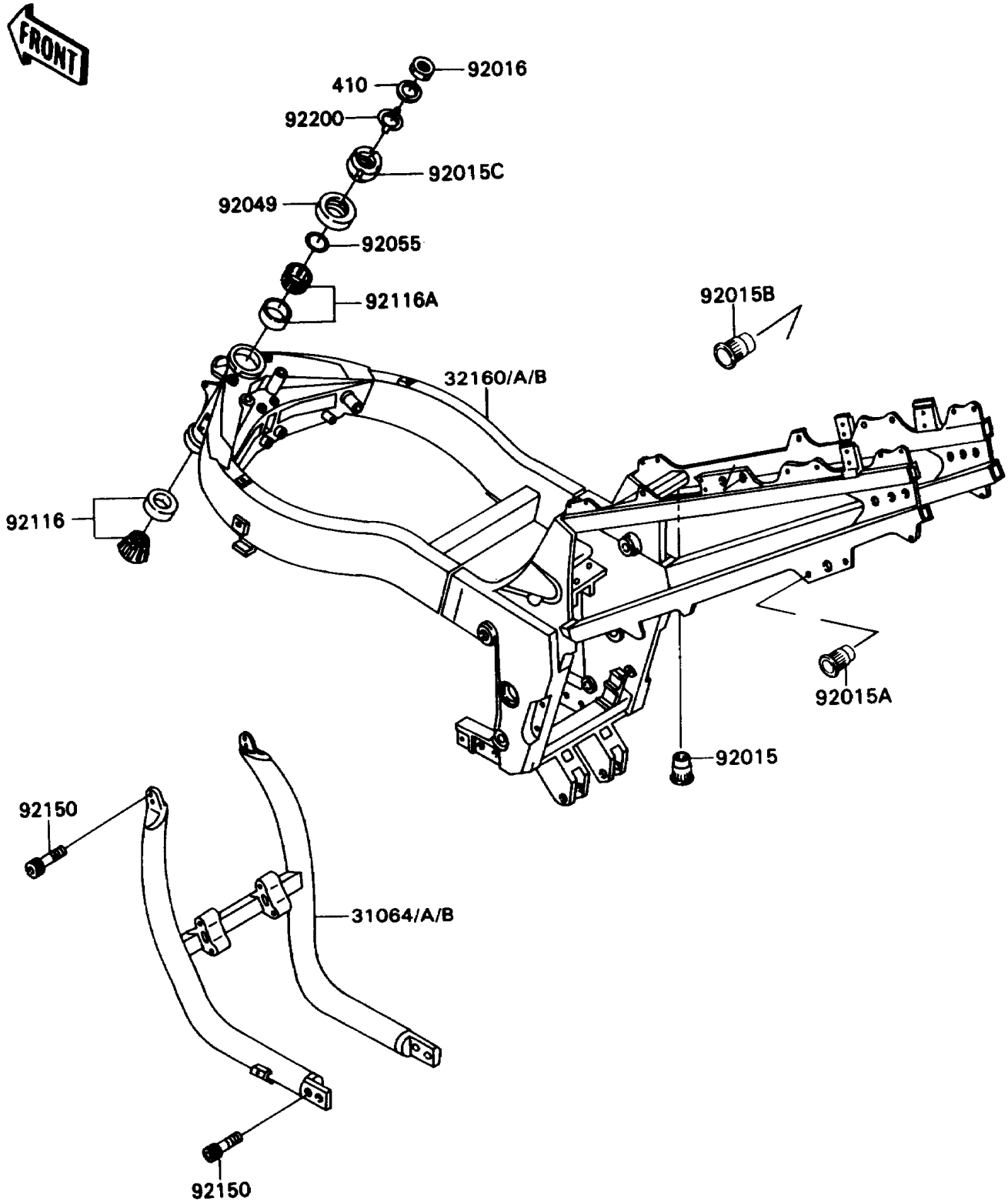

1990 NINJA® ZX™-11 PARTS LIST

Frame

ITEM NAME	PART NUMBER	QUANTITY
PIPE-COMP,SIDE FRAME,G.GRAY (Ref # 31064)	31064-1114-GD	1
PIPE-COMP,SIDE FRAME,G.GRAY (Ref # 31064A)	31064-1114-HN	1
FRAME-COMP,G.GRAY (Ref # 32160)	32160-1108-GD	1
FRAME-COMP,G.GRAY (Ref # 32160A)	32160-1108-HN	1
NUT,POP,6MM,L=15 (Ref # 92015)	92015-1791	1
NUT,POP,6MM,L=16.5 (Ref # 92015A)	92015-1792	1
NUT,POP,8MM,L=18 (Ref # 92015B)	92015-1794	1
NUT,28MM (Ref # 92015C)	92015-1813	1
NUT,20MM (Ref # 92016)	92016-028	1
SEAL-OIL (Ref # 92049)	92049-1351	1
RING-O (Ref # 92055)	92055-1470	1
BEARING-ROLLER,LWR,32006JR RS (Ref # 92116)	92116-1008	1
BEARING-ROLLER,HR320/28XJE (Ref # 92116A)	92116-1067	1
BOLT,SOCKET,10X30 (Ref # 92150)	92150-1405	1
WASHER,CLAW,20.5X32X2.3 (Ref # 92200)	92200-1041	1
W-PLAIN-S,20MM (Ref # 410)	410F2000	1