

2009 KX™450F PARTS DIAGRAM

Gear Change Mechanism

E1370

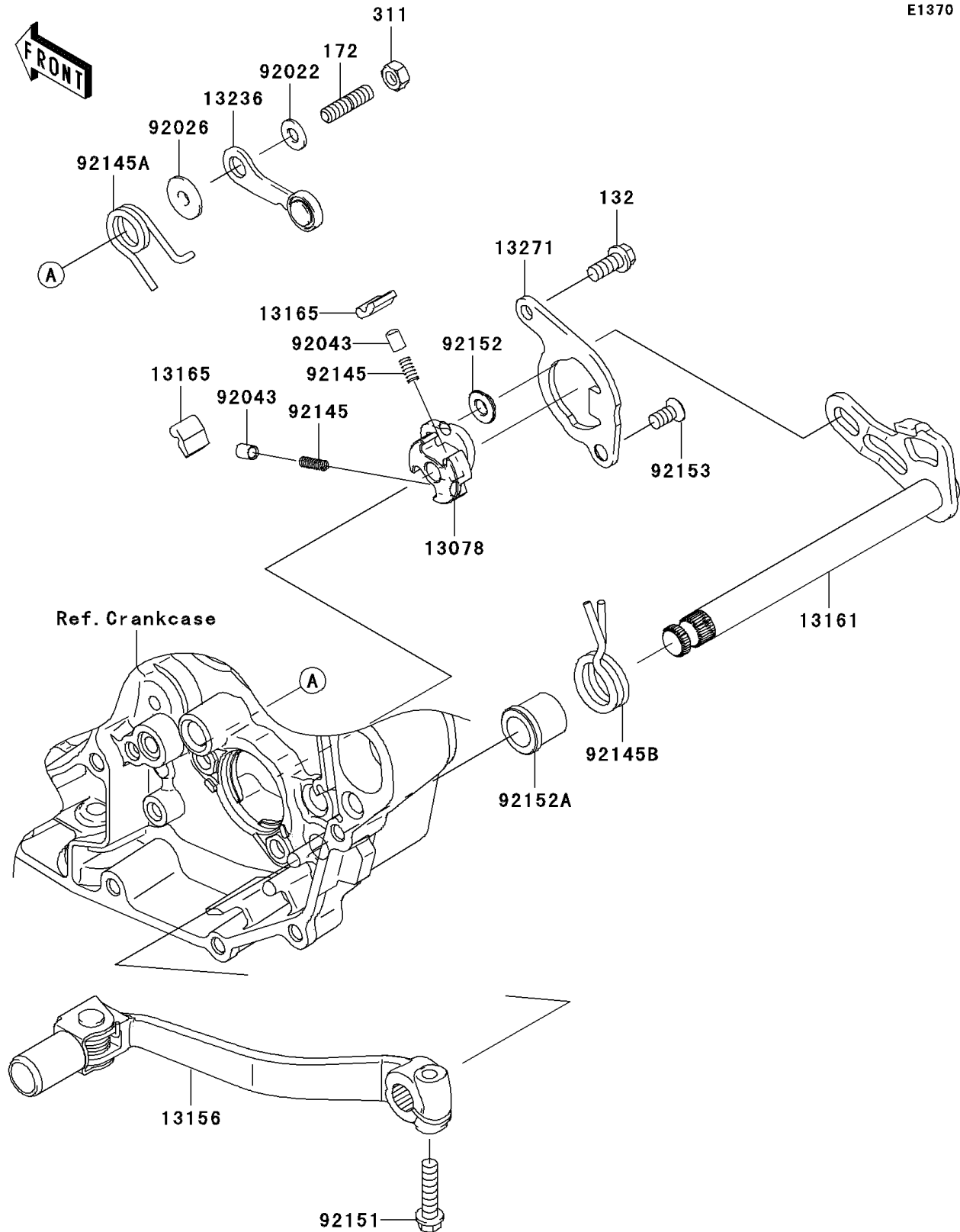

2009 KX™450F PARTS LIST

Gear Change Mechanism

ITEM NAME	PART NUMBER	QUANTITY
BOLT-FLANGED-SMALL,6X14 (Ref # 132)	132BA0614	1
BOLT-STUD,6X12 (Ref # 172)	172BA0612	1
NUT-HEX (Ref # 311)	311BA0600	1
RATCHET (Ref # 13078)	13078-0012	1
LEVER-CHANGE (Ref # 13156)	13156-0125	1
LEVER-COMP-CHANGE SHAFT (Ref # 13161)	13161-0045	1
PAWL (Ref # 13165)	13165-0018	1
LEVER-COMP,POSITION (Ref # 13236)	13236-0129	1
PLATE,PAWL GUIDE (Ref # 13271)	13271-0893	1
WASHER,6X12.8X1.2 (Ref # 92022)	92022-1827	1
SPACER (Ref # 92026)	92026-1217	1
PIN,PLUNGER (Ref # 92043)	92043-1676	1
SPRING (Ref # 92145)	92145-0453	1
SPRING (Ref # 92145A)	92145-0457	1
SPRING,RETURN (Ref # 92145B)	92145-0496	1
BOLT,FLANGED-SMALL,6X25 (Ref # 92151)	92151-1930	1
COLLAR (Ref # 92152)	92152-1414	1
COLLAR,RETURN SPRING (Ref # 92152A)	92152-1419	1
BOLT,TORX,6X8.7 (Ref # 92153)	92153-1669	1