

2009 KX™250F PARTS DIAGRAM

Cylinder/Piston(s)

E1120

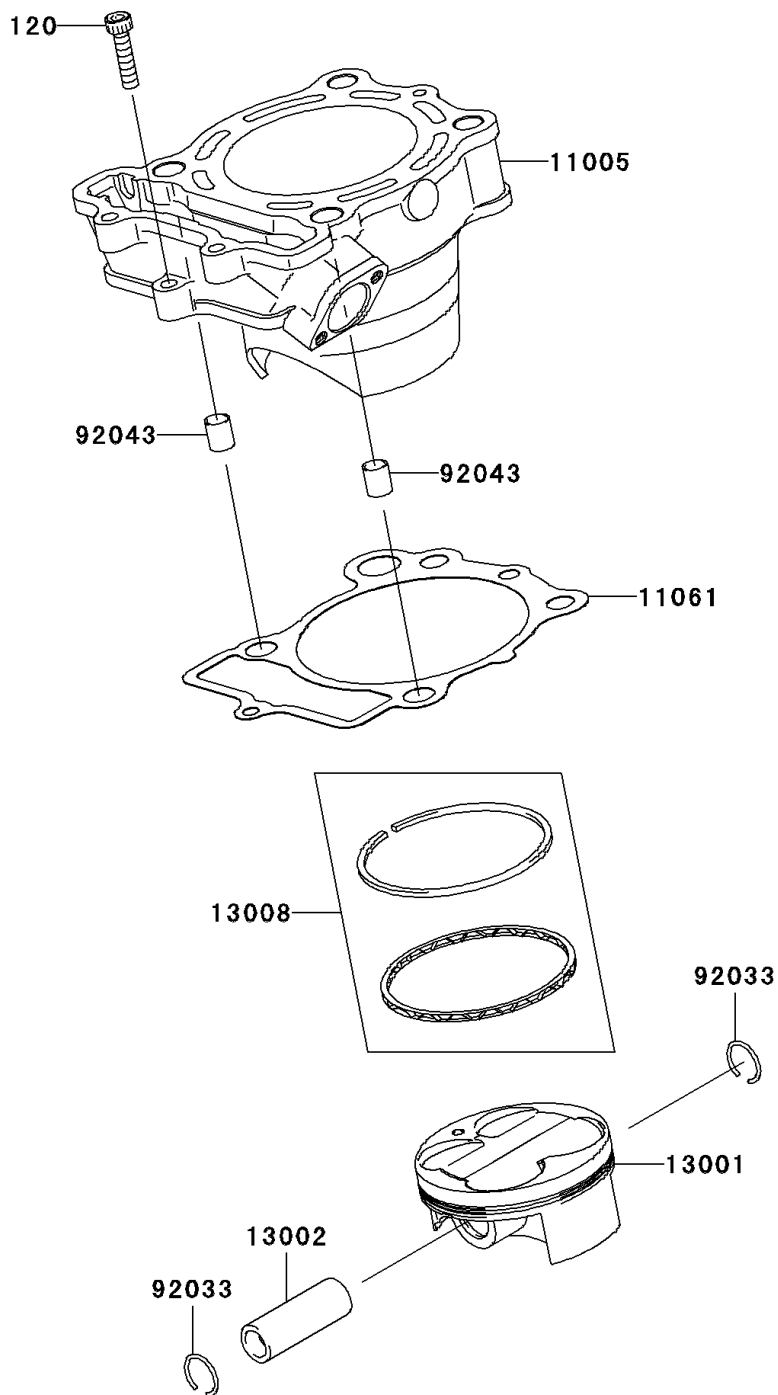

2009 KX™250F PARTS LIST

Cylinder/Piston(s)

ITEM NAME	PART NUMBER	QUANTITY
BOLT-SOCKET,6X25 (Ref # 120)	120CA0625	1
CYLINDER-ENGINE (Ref # 11005)	11005-0110	1
GASKET,CYLINDER BASE (Ref # 11061)	11061-0357	1
PISTON-ENGINE (Ref # 13001)	13001-0088	1
PIN-PISTON (Ref # 13002)	13002-0024	1
RING-SET-PISTON (Ref # 13008)	13008-0028	1
RING-SNAP,PISTON PIN (Ref # 92033)	92033-1161	1
PIN,10.1X12X14 (Ref # 92043)	92043-4009	1