

2008 Vulcan® 2000 PARTS DIAGRAM

Left Engine Cover(s)

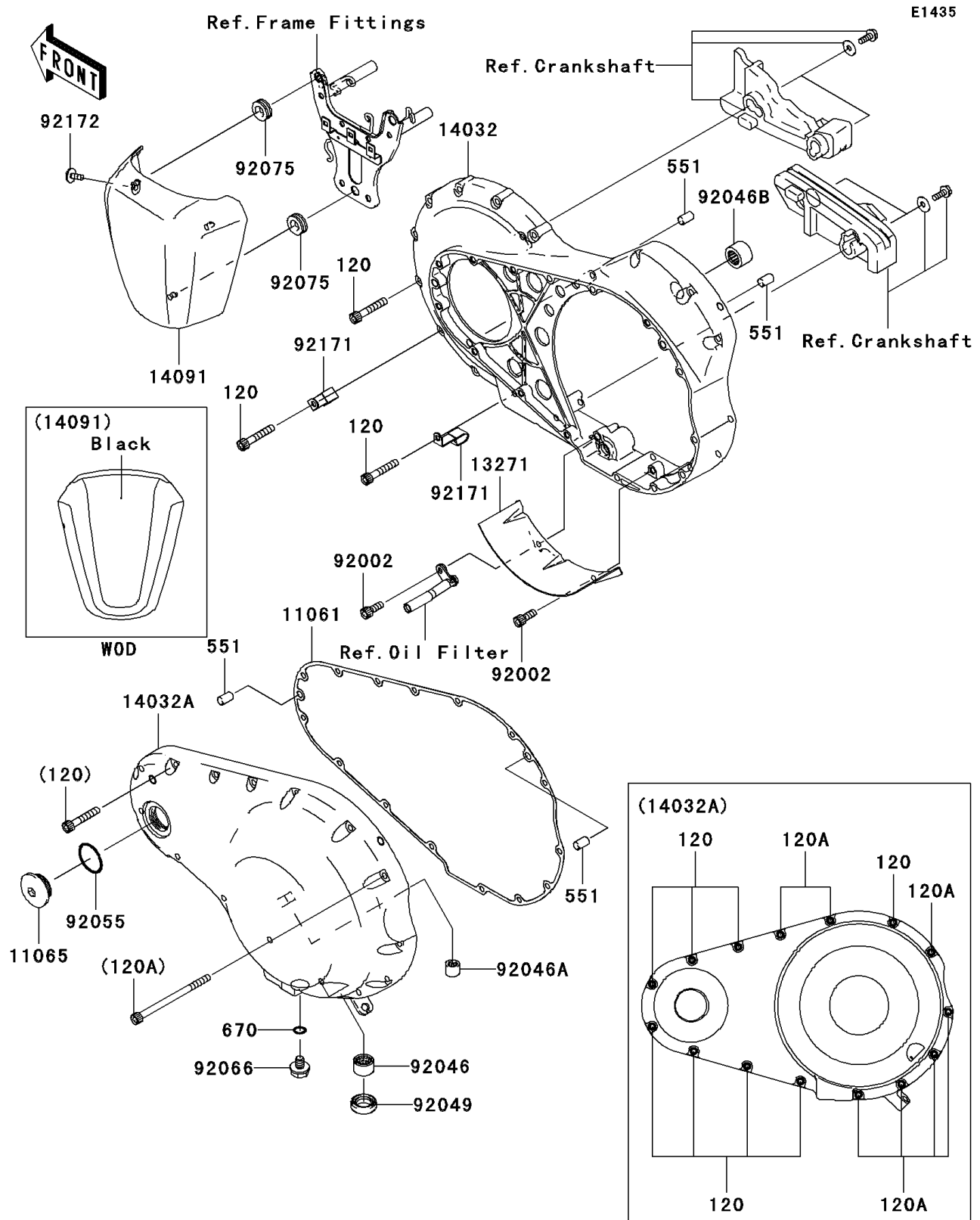

2008 Vulcan® 2000 PARTS LIST

Left Engine Cover(s)

ITEM NAME	PART NUMBER	QUANTITY
BOLT-SOCKET,6X35 (Ref # 120)	120R0635	1
BOLT-SOCKET,6X90 (Ref # 120A)	120R0690	1
PIN-DOWEL,8X14 (Ref # 551)	551A0814	1
O RING,8MM (Ref # 670)	670D1508	1
GASKET,CLUTCH,OUTSIDE (Ref # 11061)	11061-0016	1
CAP (Ref # 11065)	11065-0025	1
PLATE (Ref # 13271)	13271-0083	1
COVER-CLUTCH,INNER (Ref # 14032)	14032-0009	1
COVER-CLUTCH,OUTER (Ref # 14032A)	14032-0073	1
COVER,IGNITION COIL,M.D,BLACK (Ref # 14091)	14091-0882-17K	1
BOLT,SOCKET,6X16 (Ref # 92002)	92002-1778	1
BEARING-NEEDLE,HK1210 (Ref # 92046)	92046-1010	1
BEARING-NEEDLE,HK0709 (Ref # 92046A)	92046-1142	1
BEARING-NEEDLE,HK1212 (Ref # 92046B)	92046-1163	1
SEAL-OIL,CLUTCH RELEASE (Ref # 92049)	92049-1475	1
RING-O,31.7X2.4 (Ref # 92055)	92055-049	1
PLUG,DRAIN,8X10 (Ref # 92066)	92066-1026	1
DAMPER (Ref # 92075)	92075-1629	1
CLAMP,SENSOR CODE (Ref # 92171)	92171-0153	1
SCREW,5X12 (Ref # 92172)	92172-0101	1