

1994 KX™80 PARTS DIAGRAM

Cylinder Head/Cylinder

E1110

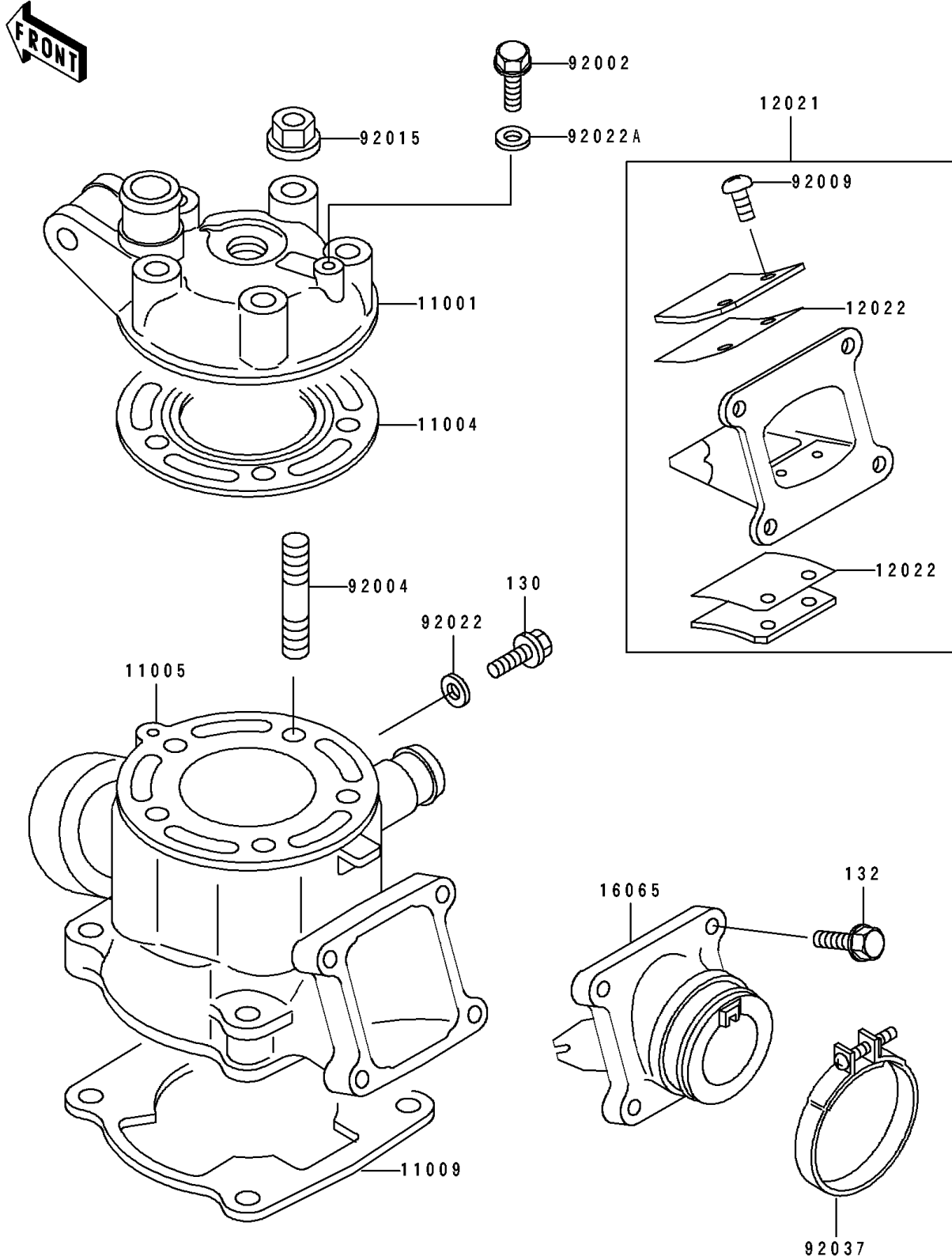

1994 KX™80 PARTS LIST

Cylinder Head/Cylinder

ITEM NAME	PART NUMBER	QUANTITY
HEAD-CYLINDER (Ref # 11001)	11001-1371	1
GASKET-HEAD (Ref # 11004)	11004-1213	1
CYLINDER-ENGINE (Ref # 11005)	11005-1674	1
GASKET,CYLINDER BASE (Ref # 11009)	11009-1970	1
VALVE-ASSY-REED (Ref # 12021)	12021-1075	1
VALVE-REED (Ref # 12022)	12022-1054	1
HOLDER-CARBURETOR (Ref # 16065)	16065-1224	1
BOLT,6X10 (Ref # 92002)	92002-1222	1
STUD,8X32 (Ref # 92004)	92004-1197	1
SCREW,REED VALVE (Ref # 92009)	92009-1014	1
NUT,8MM (Ref # 92015)	92015-1143	1
WASHER,6.1X12X1 (Ref # 92022)	92022-077	1
WASHER,6.2X11X1 (Ref # 92022A)	92022-304	1
CLAMP (Ref # 92037)	92037-1843	1
BOLT-FLANGED,6X8 (Ref # 130)	130B0608	1
BOLT-FLANGED-SMALL (Ref # 132)	132G0620	1