

1988 KX™500 PARTS DIAGRAM

Footrests

F2160-0173

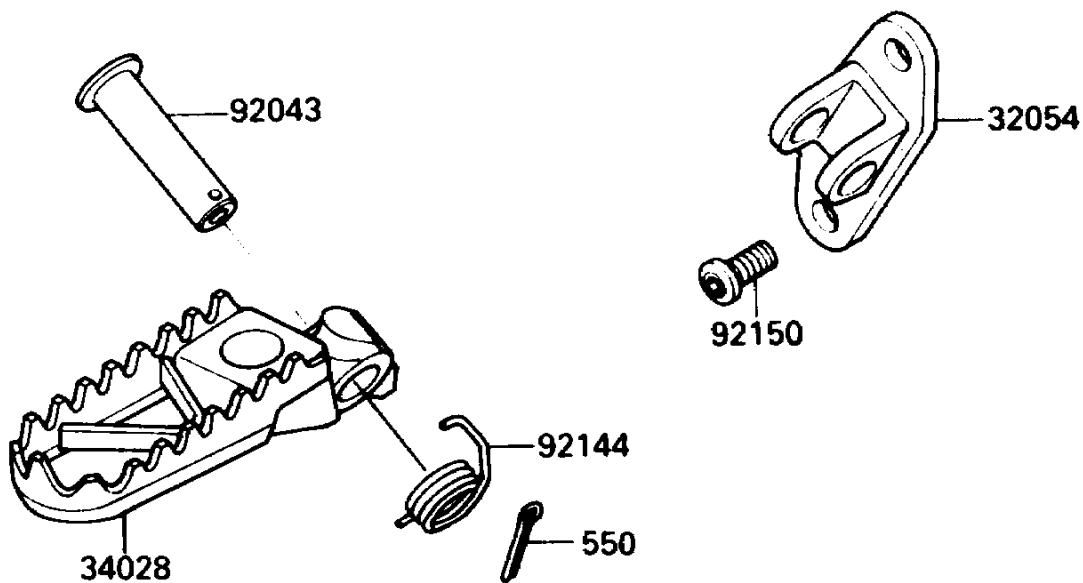
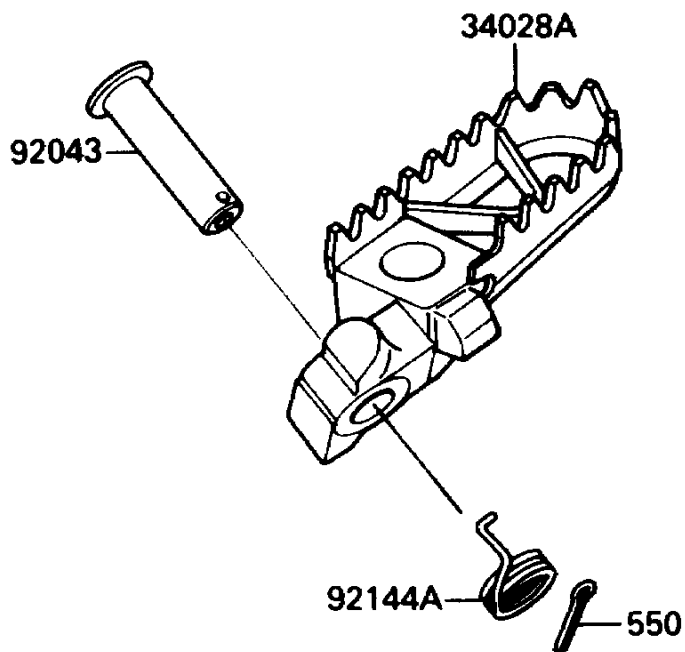

1988 KX™500 PARTS LIST

Footrests

ITEM NAME	PART NUMBER	QUANTITY
BRACKET-STEP (Ref # 32054)	32054-1164	1
STEP,LH (Ref # 34028)	34028-1233	1
STEP,RH (Ref # 34028A)	34028-1234	1
PIN,10X45.5 (Ref # 92043)	92043-1372	1
SPRING,STEP,LH (Ref # 92144)	92144-1249	1
SPRING,STEP,RH (Ref # 92144A)	92144-1250	1
BOLT,SOCKET,10X16 (Ref # 92150)	92150-1111	1
PIN-COTTER,3.0X20 (Ref # 550)	550D3020	1