

## 2000 KX™250 PARTS DIAGRAM

Brake Pedal

F2260

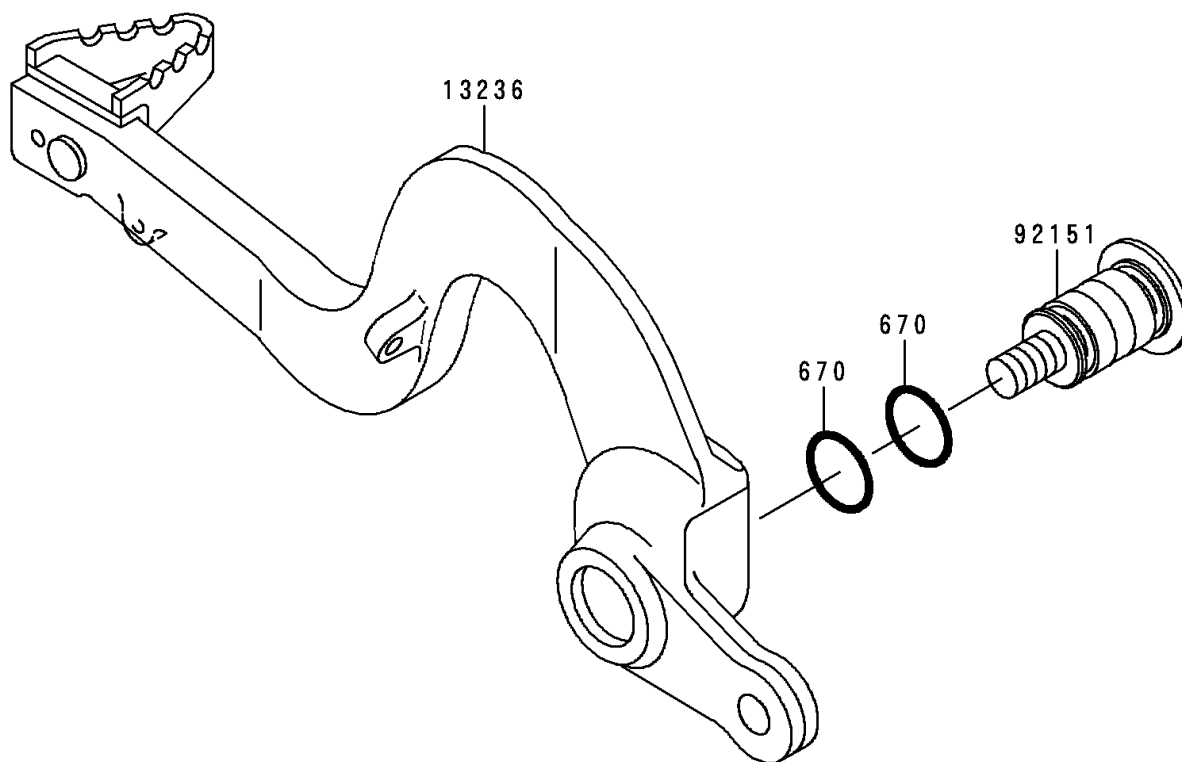
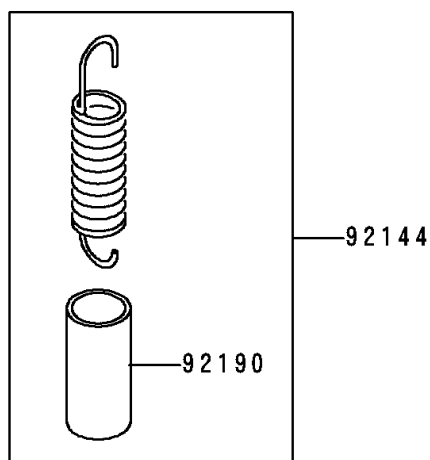

## 2000 KX™250 PARTS LIST

Brake Pedal

ITEM NAME	PART NUMBER	QUANTITY
O RING,12MM (Ref # 670)	670B2012	1
LEVER-COMP,PEDAL (Ref # 13236)	13236-1339	1
SPRING,BRAKE PEDAL RETURN (Ref # 92144)	92144-1752	1
BOLT (Ref # 92151)	92151-1572	1
TUBE,13X16X25 (Ref # 92190)	92190-1488	1