

1994 KX™125 PARTS DIAGRAM

Crankshaft/Piston(s)

E1320

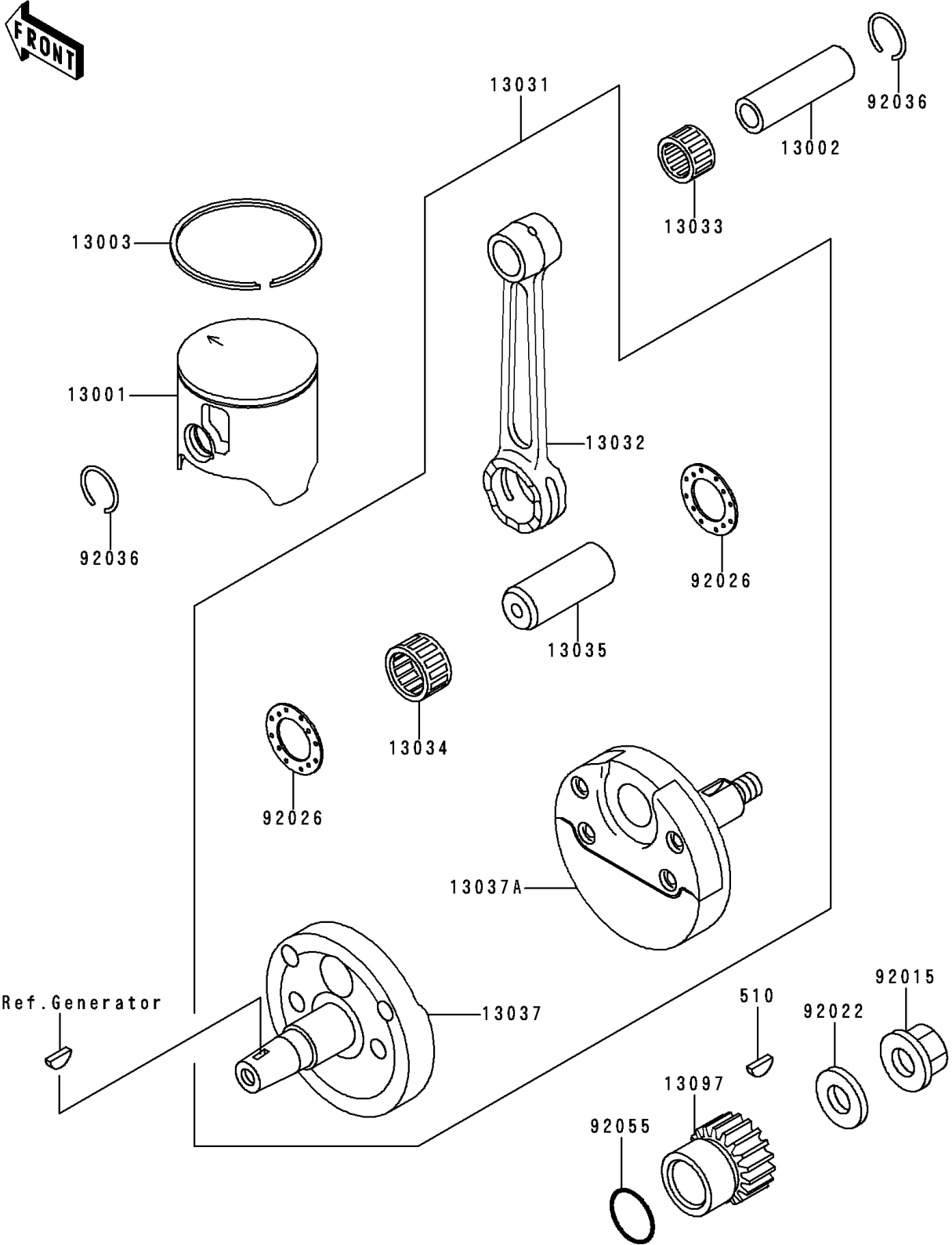

1994 KX™125 PARTS LIST

Crankshaft/Piston(s)

ITEM NAME	PART NUMBER	QUANTITY
KEY-WOODRUFF (Ref # 510)	510A5100	1
PISTON-ENGINE (Ref # 13001)	13001-1396	1
PIN-PISTON (Ref # 13002)	13002-1099	1
RING-PISTON TOP (Ref # 13003)	13003-1318	1
CRANKSHAFT-COMP (Ref # 13031)	13031-1366	1
ROD-CONNECTING (Ref # 13032)	13032-1196	1
BEARING-SMALL END (Ref # 13033)	13033-1057	1
BEARING-BIG END,B4 (Ref # 13034)	13034-1097	1
PIN-CRANK (Ref # 13035)	13035-1010	1
CRANKSHAFT,LH (Ref # 13037)	13037-1482	1
CRANKSHAFT,RH (Ref # 13037A)	13037-1484	1
GEAR-PRIMARY SPUR,20T (Ref # 13097)	13097-1311	1
NUT,FLANGED,12MM (Ref # 92015)	92015-1156	1
WASHER (Ref # 92022)	92022-1831	1
SPACER,22.2X37X1.0 (Ref # 92026)	92026-1136	1
RING-SNAP (Ref # 92036)	92036-005	1
RING-O (Ref # 92055)	92055-086	1