

2017 PARTS DIAGRAM

Meter(s)

F2530

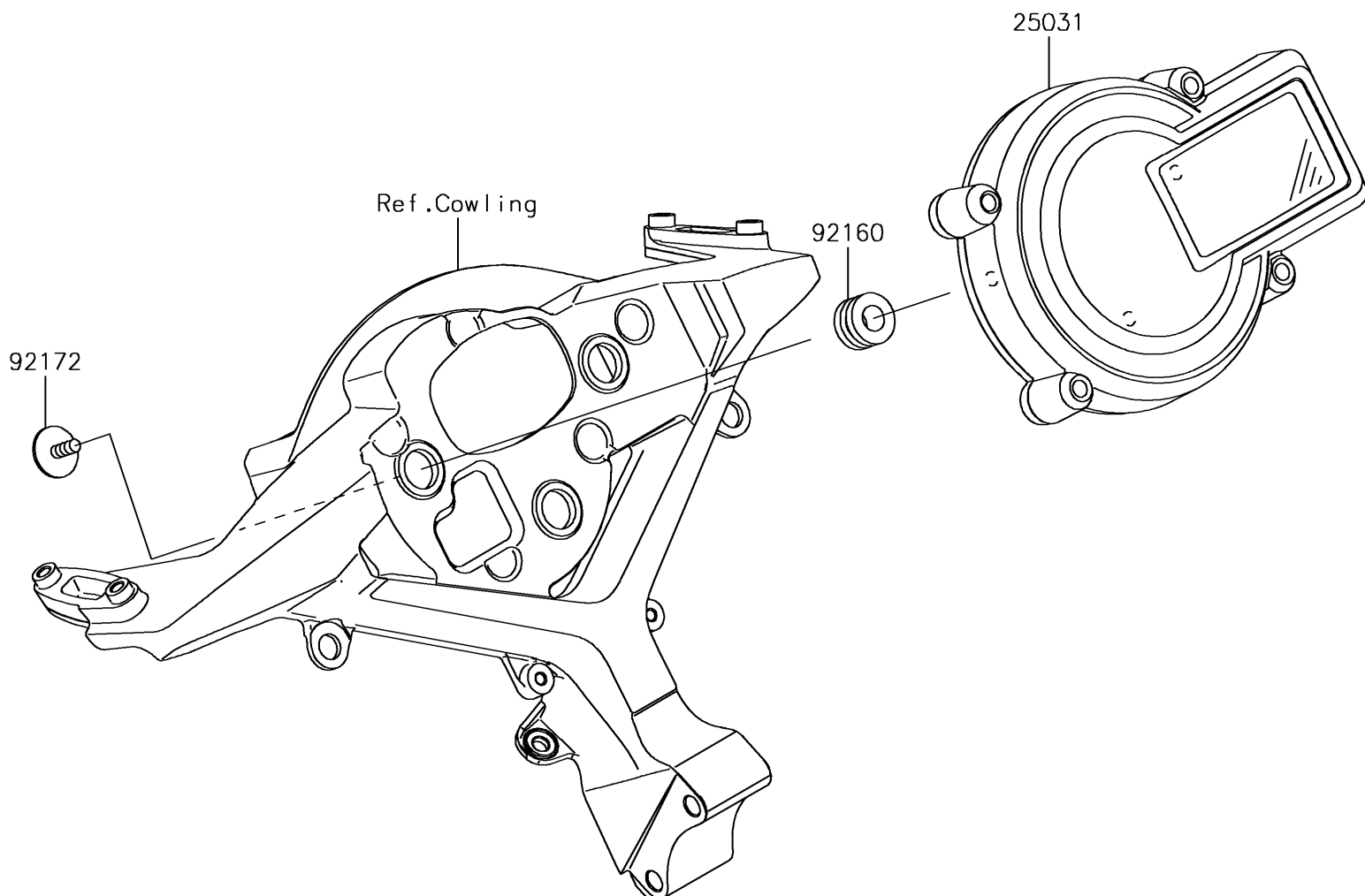

2017 PARTS LIST

Meter(s)

ITEM NAME	PART NUMBER	QUANTITY
METER-ASSY,COMBINATION (Ref # 25031)	25031-0738	1
DAMPER,10X20X12 (Ref # 92160)	92160-1167	1
SCREW,TAPPING,WP,5X14 (Ref # 92172)	92172-0441	1