

2018 MULE PRO-FX™ PARTS DIAGRAM

Seat

F2510

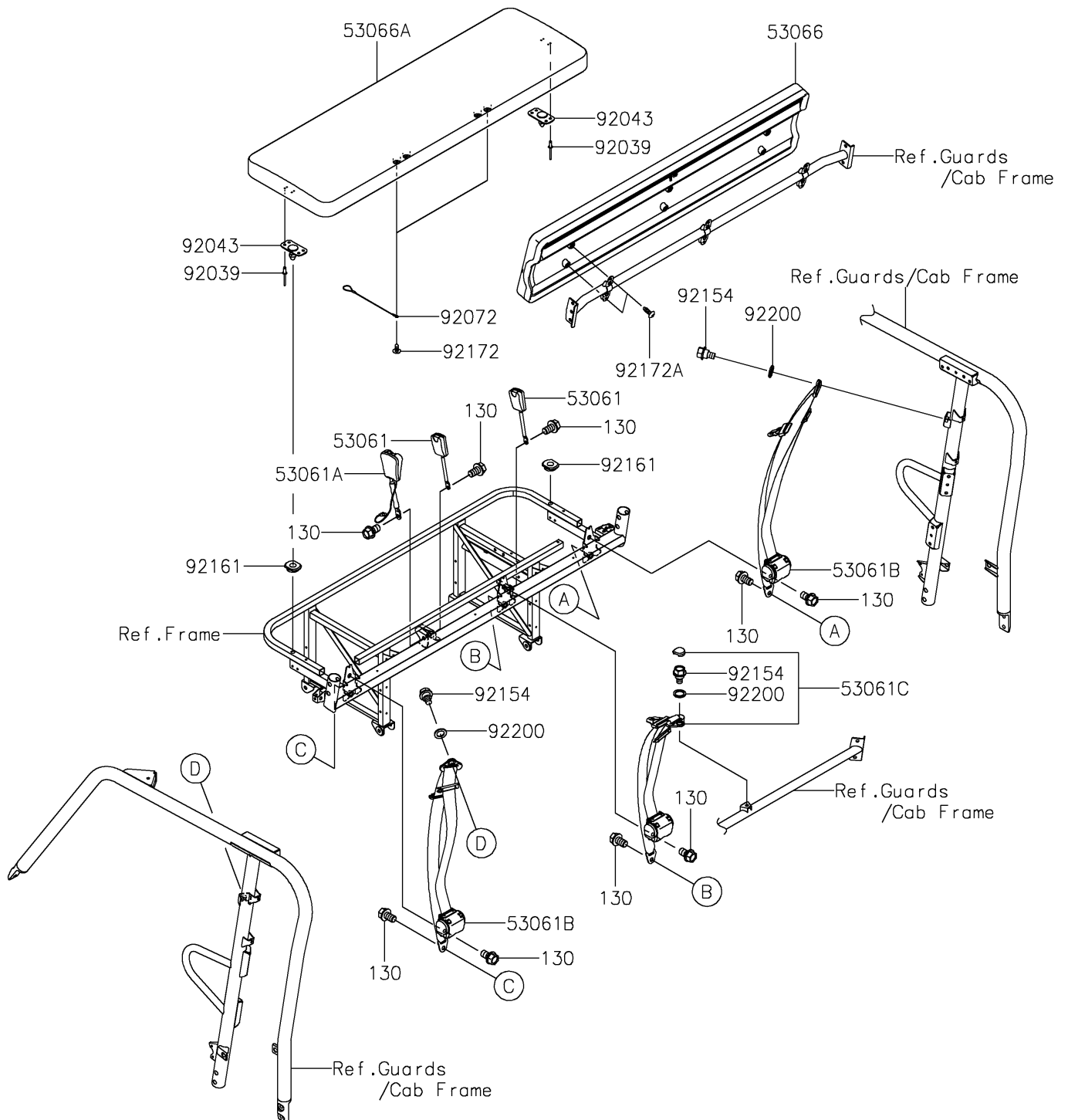

2018 MULE PRO-FX™ PARTS LIST

Seat

ITEM NAME	PART NUMBER	QUANTITY
BOLT-FLANGED,12X20 (Ref # 130)	130BA1220	1
BELT-SEAT,BUCKLE (Ref # 53061)	53061-0039	1
BELT-SEAT,BUCKLE,SW. (Ref # 53061A)	53061-0338	1
BELT-SEAT,FR,LH&RH (Ref # 53061B)	53061-0340	1
BELT-SEAT,MIDDLE (Ref # 53061C)	53061-0341	1
SEAT-ASSY,BACK,BLACK (Ref # 53066)	53066-0426-MA	1
SEAT-ASSY,BOTTOM,BLACK (Ref # 53066A)	53066-0495-MA	1
RIVET (Ref # 92039)	92039-0747	1
PIN (Ref # 92043)	92043-0859	1
BAND (Ref # 92072)	92072-0769	1
BOLT,FLANGED,10X19.5 (Ref # 92154)	92154-1959	1
DAMPER,10.5X30X8.2 (Ref # 92161)	92161-1784	1
SCREW,6X16 (Ref # 92172)	92172-0284	1
SCREW,TAPPING,6X20 (Ref # 92172A)	92172-0488	1
WASHER,16X22X2 (Ref # 92200)	92200-1798	1