

2015 Brute Force® 750 4x4i EPS PARTS DIAGRAM

Valve(s)

E1210

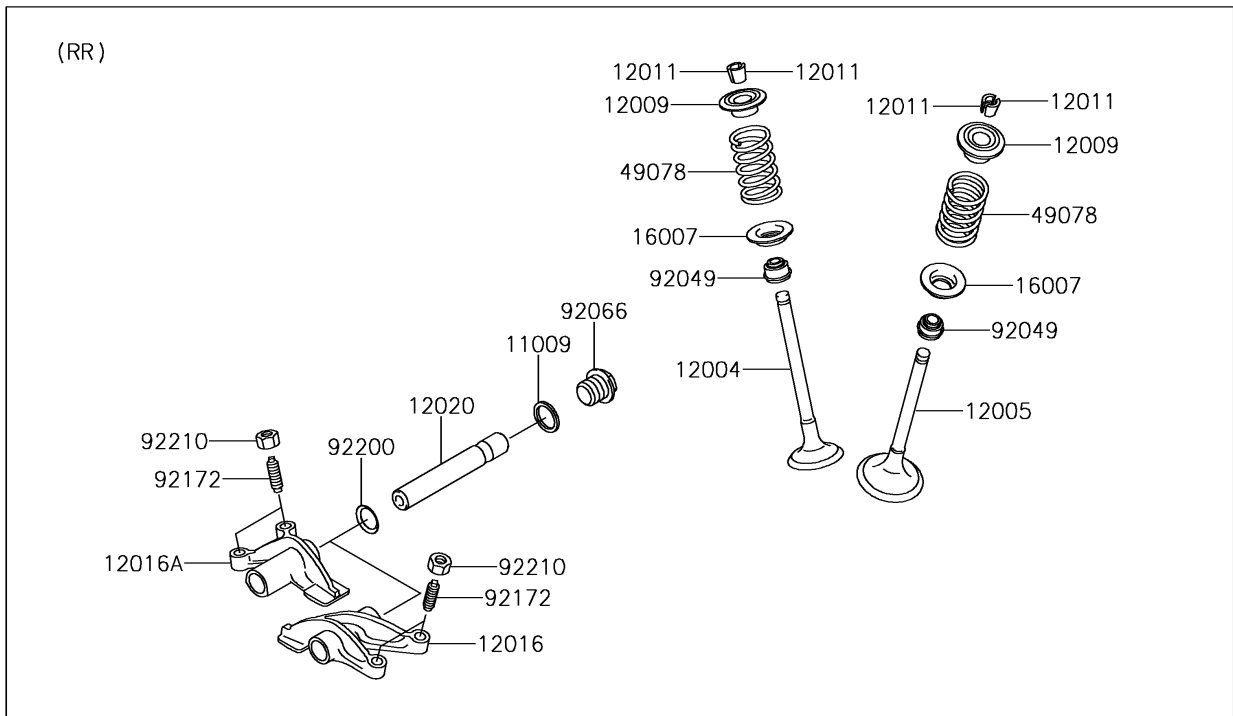
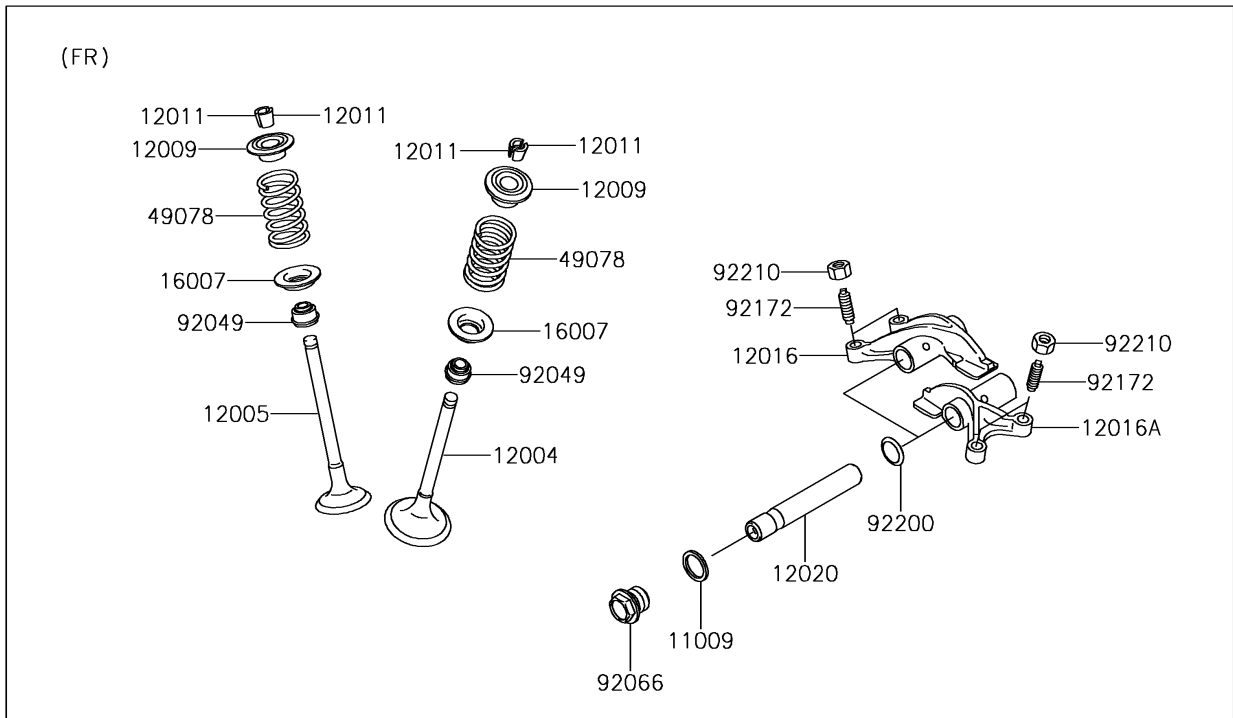

2015 Brute Force® 750 4x4i EPS PARTS LIST

Valve(s)

ITEM NAME	PART NUMBER	QUANTITY
GASKET,14X18X1.5 (Ref # 11009)	11009-1430	1
VALVE-INTAKE (Ref # 12004)	12004-0717	1
VALVE-EXHAUST (Ref # 12005)	12005-0047	1
RETAINER-VALVE SPRING (Ref # 12009)	12009-1056	1
COLLET (Ref # 12011)	12011-1051	1
ARM-ROCKER,EXHAUST (Ref # 12016)	12016-1128	1
ARM-ROCKER,INTAKE (Ref # 12016A)	12016-1129	1
SHAFT-ROCKER (Ref # 12020)	12020-0004	1
SEAT-SPRING (Ref # 16007)	16007-0703	1
SPRING-ENGINE VALVE (Ref # 49078)	49078-0014	1
SEAL-OIL,VSB58.558 (Ref # 92049)	92049-1218	1
PLUG,DRAIN (Ref # 92066)	92066-2196	1
SCREW,6MM (Ref # 92172)	92172-0737	1
WASHER,13X17X0.3 (Ref # 92200)	92200-0808	1
NUT,6MM (Ref # 92210)	92210-1490	1