

2016 NINJA® 300 PARTS DIAGRAM

Swingarm

F2141

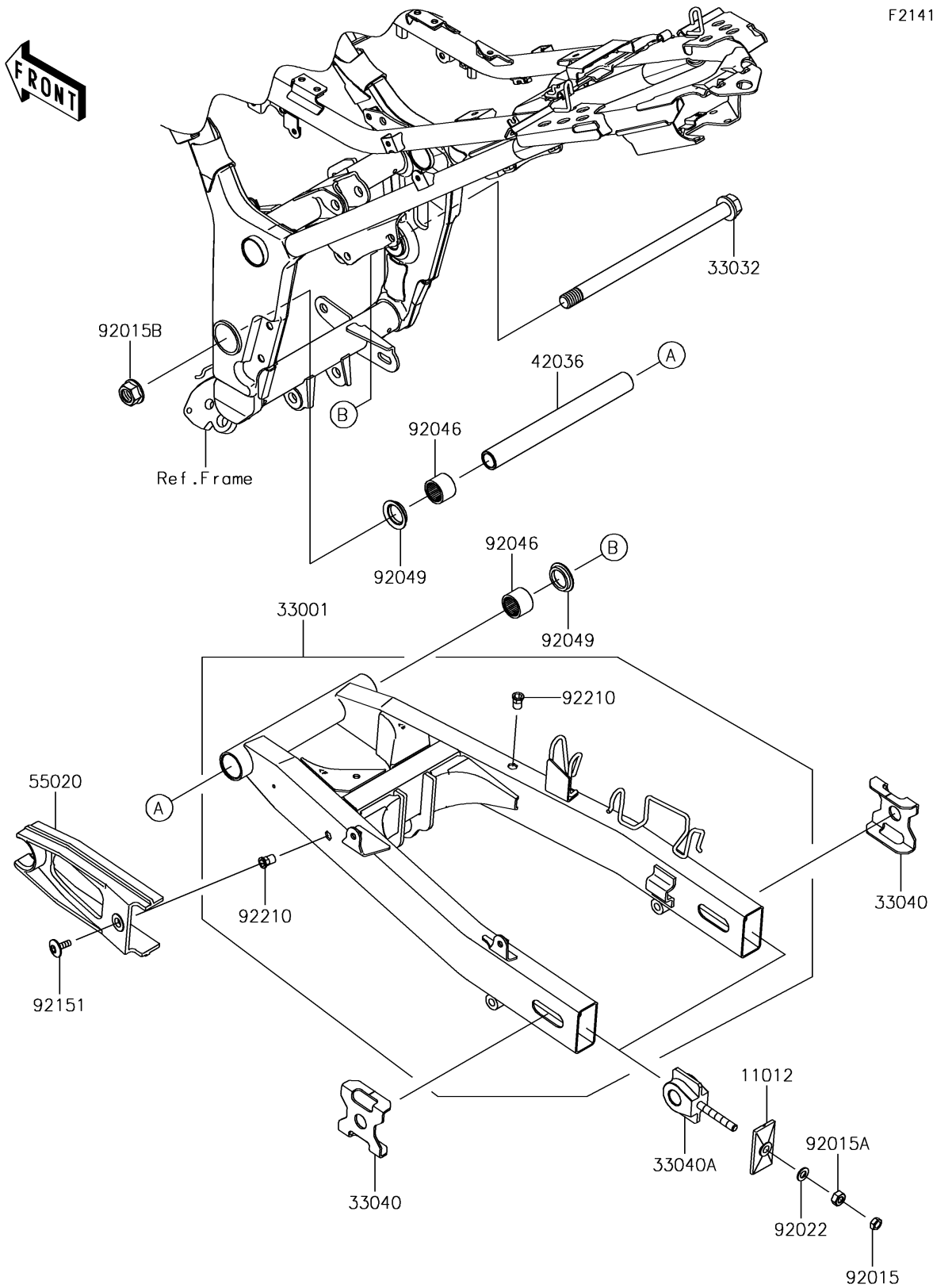

2016 NINJA® 300 PARTS LIST

Swingarm

ITEM NAME	PART NUMBER	QUANTITY
CAP,CHAIN ADJUSTER,F.S.BLACK (Ref # 11012)	11012-1871-18R	1
ARM-COMP-SWING,F.S.BLACK (Ref # 33001)	33001-0632-18R	1
SHAFT-SWING ARM (Ref # 33032)	33032-1134	1
ADJUSTER-CHAIN,OUTER,F.S.BLACK (Ref # 33040)	33040-0030-18R	1
ADJUSTER-CHAIN,INNER (Ref # 33040A)	33040-1116	1
SLEEVE,16.1X22X213 (Ref # 42036)	42036-1218	1
GUARD,CHAIN (Ref # 55020)	55020-0317	1
NUT,8MM (Ref # 92015)	92015-1364	1
NUT,8MM (Ref # 92015A)	92015-1658	1
NUT,FLANGED,16MM (Ref # 92015B)	92015-1946	1
WASHER,8.5X16X1.2 (Ref # 92022)	92022-1582	1
BEARING-NEEDLE,22X28X20 (Ref # 92046)	92046-0610	1
SEAL-OIL,MHA22 28 5.7F (Ref # 92049)	92049-1254	1
BOLT,SOCKET,6X18 (Ref # 92151)	92151-1149	1
NUT,POP,6MM,L=15 (Ref # 92210)	92210-1397	1