

2016 MULE PRO-FX™ EPS Camo PARTS DIAGRAM

Drive Shaft-Front

E3136

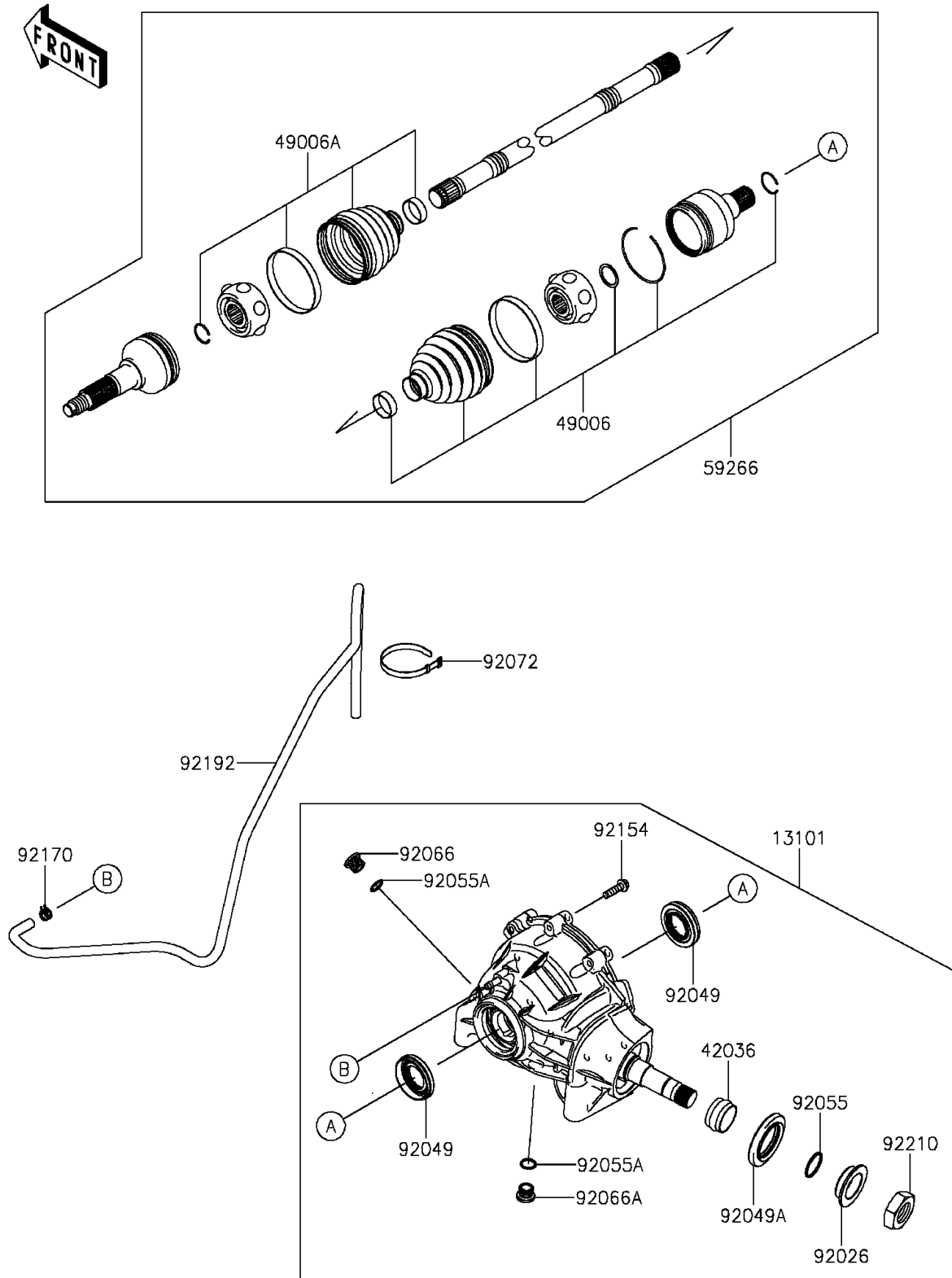

2016 MULE PRO-FX™ EPS Camo PARTS LIST

Drive Shaft-Front

ITEM NAME	PART NUMBER	QUANTITY
GEAR-ASSY,FRONT DIFFERENTIAL (Ref # 13101)	13101-0662	1
SLEEVE (Ref # 42036)	42036-0741	1
BOOT,INSIDE (Ref # 49006)	49006-0578	1
BOOT,OUTSIDE (Ref # 49006A)	49006-0584	1
JOINT-BALL,FR (Ref # 59266)	59266-0710	1
SPACER (Ref # 92026)	92026-0776	1
SEAL-OIL,33X60X7 (Ref # 92049)	92049-0760	1
SEAL-OIL,44X72X7 (Ref # 92049A)	92049-0766	1
RING-O (Ref # 92055)	92055-0788	1
RING-O,15.3X2.2 (Ref # 92055A)	92055-0830	1
PLUG (Ref # 92066)	92066-0777	1
PLUG (Ref # 92066A)	92066-0778	1
BAND,L=186 (Ref # 92072)	92072-056	1
BOLT,FLANGED,8X30 (Ref # 92154)	92154-1370	1
CLAMP (Ref # 92170)	92170-2082	1
TUBE,BREATHING (Ref # 92192)	92192-1341	1
NUT (Ref # 92210)	92210-0894	1