

1998 Bayou® 300 4x4 PARTS DIAGRAM

Brake Pedal

F2260

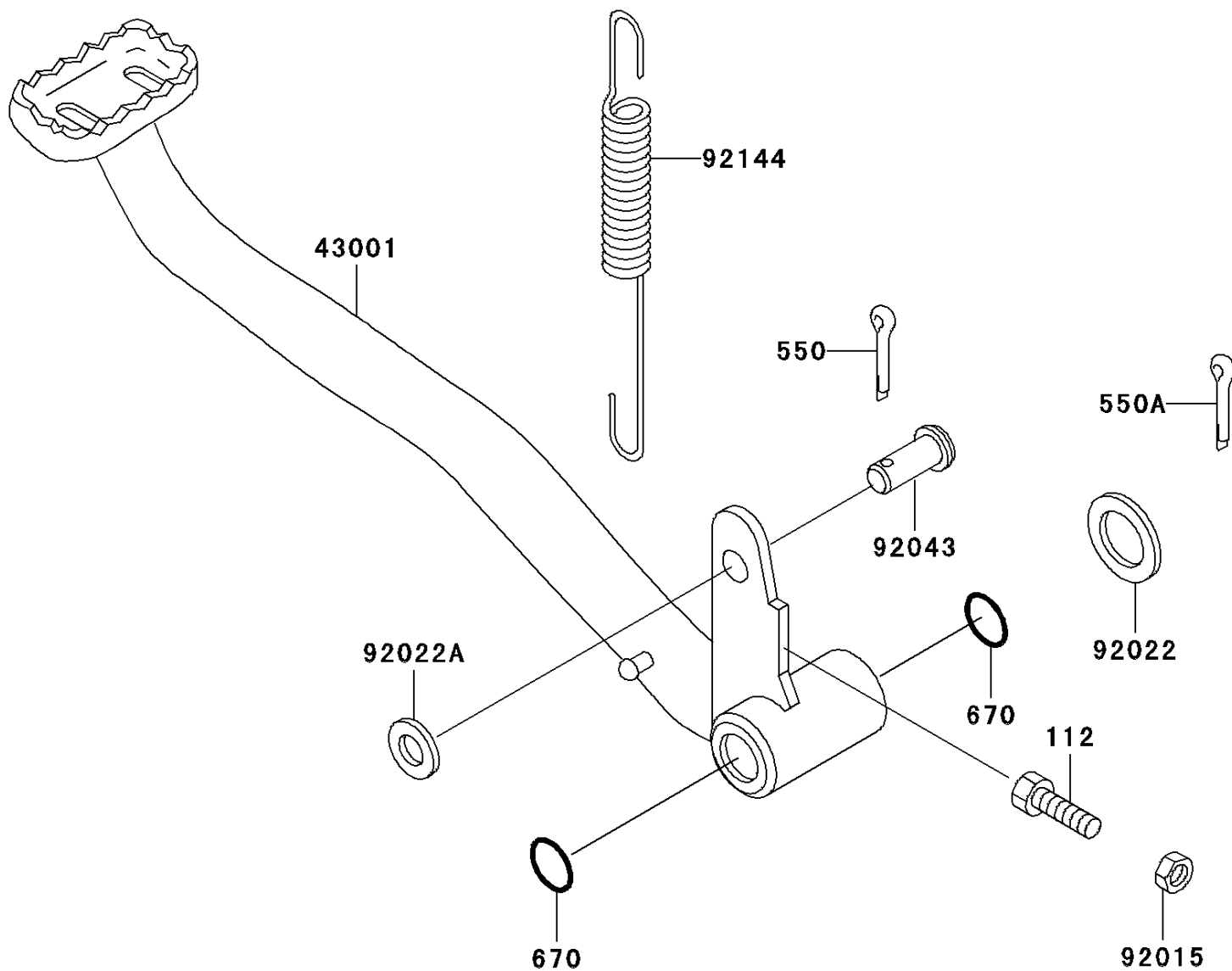

1998 Bayou® 300 4x4 PARTS LIST

Brake Pedal

ITEM NAME	PART NUMBER	QUANTITY
BOLT-UPSET (Ref # 112)	112D0622	1
PIN-COTTER,2.0X15 (Ref # 550)	550D2015	1
PIN-COTTER,2.5X25 (Ref # 550A)	550D2525	1
O RING,15MM (Ref # 670)	670B2015	1
LEVER-BRAKE,PEDAL (Ref # 43001)	43001-1253	1
NUT,6MM (Ref # 92015)	92015-1410	1
WASHER,15.5X24X1.6 (Ref # 92022)	92022-1049	1
WASHER,8.5X16X1.2 (Ref # 92022A)	92022-1582	1
PIN,8X16 (Ref # 92043)	92043-1013	1
SPRING,BRAKE PEDAL RETURN (Ref # 92144)	92144-1317	1