

1997 KE100 PARTS DIAGRAM

Chassis Electrical Equipment

F2760

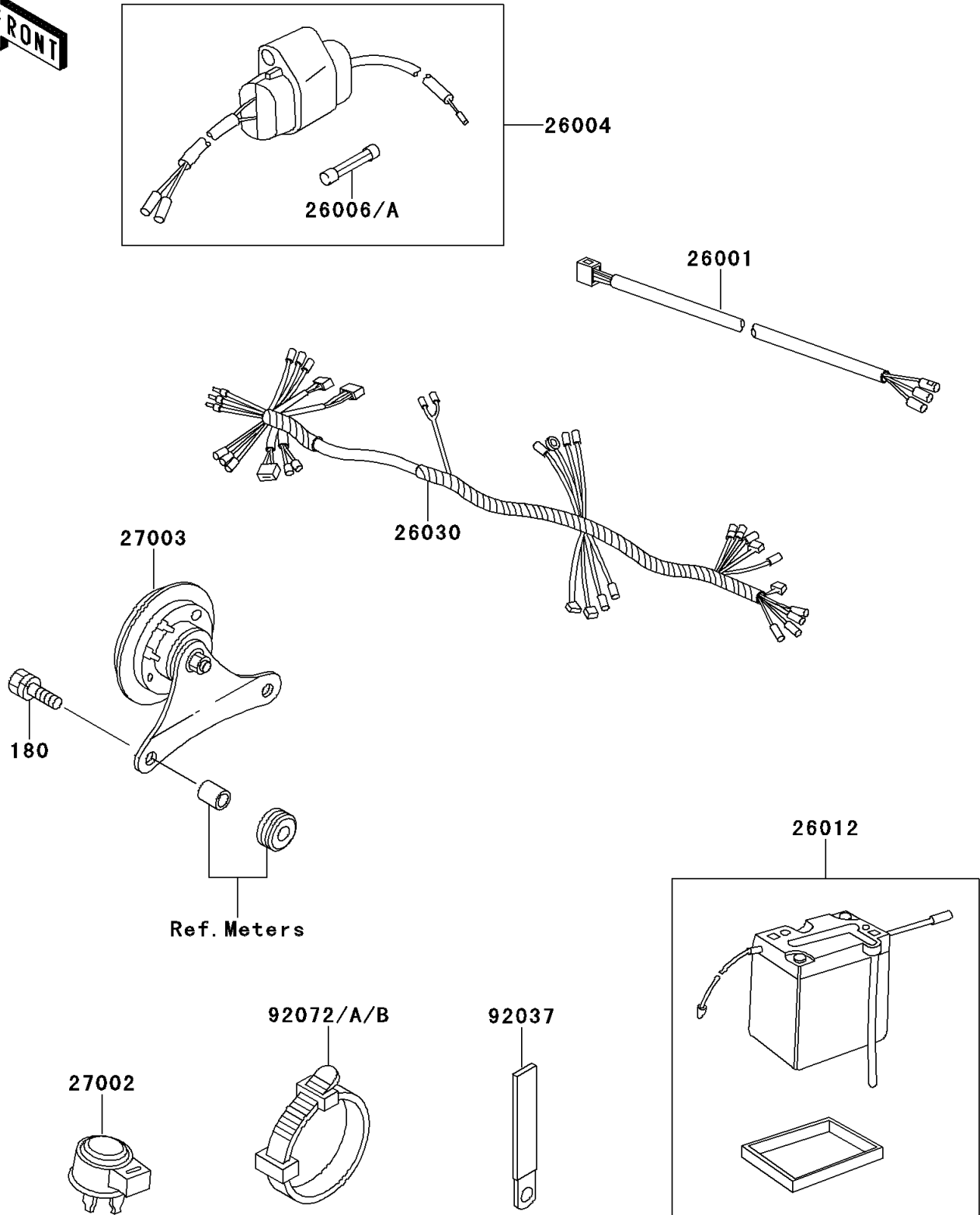

1997 KE100 PARTS LIST

Chassis Electrical Equipment

ITEM NAME	PART NUMBER	QUANTITY
BOLT-UPSET-WS,6X25 (Ref # 180)	180C0625	1
HARNESS,TAIL LAMP (Ref # 26001)	26001-1007	1
FUSE-ASSY (Ref # 26004)	26004-1105	1
FUSE,10A,L=30 (Ref # 26006)	26006-1002	1
FUSE,15A,L=30 (Ref # 26006A)	26006-1003	1
BATTERY,6N6-1D-2,6V 6AH (Ref # 26012)	26012-1291	1
HARNESS,MAIN (Ref # 26030)	26030-1455	1
RELAY-ASSY,TURN SIGNAL (Ref # 27002)	27002-013	1
HORN (Ref # 27003)	27003-1052	1
CLAMP,WIRING HARNESS,L=60 (Ref # 92037)	92037-1069	1
BAND,L=123 (Ref # 92072)	92072-030	1
BAND,L=149 (Ref # 92072A)	92072-031	1
BAND,L=218 (Ref # 92072B)	92072-032	1