

## 2000 KDX™200 PARTS DIAGRAM

Gear Change Mechanism

E1370

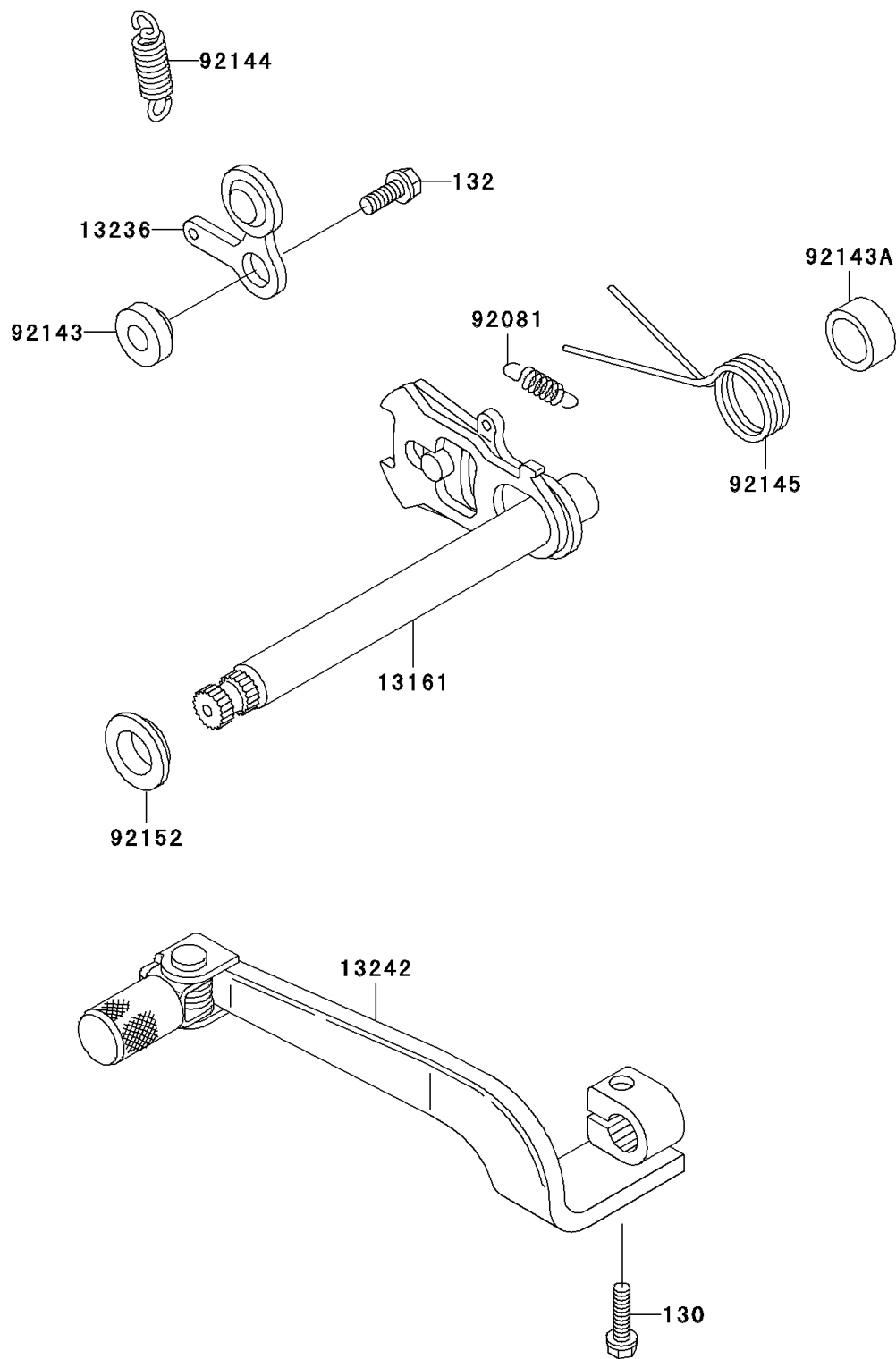

## 2000 KDX™200 PARTS LIST

Gear Change Mechanism

ITEM NAME	PART NUMBER	QUANTITY
BOLT-FLANGED (Ref # 130)	130Z0630	1
BOLT-FLANGED-SMALL (Ref # 132)	132Y0616	1
LEVER-COMP-CHANGE SHAFT (Ref # 13161)	13161-1217	1
LEVER-COMP,POSITION (Ref # 13236)	13236-1189	1
LEVER-ASSY-CHANGE,PEDAL (Ref # 13242)	13242-1319	1
SPRING,CHANGE LEVER (Ref # 92081)	92081-076	1
COLLAR (Ref # 92143)	92143-1055	1
COLLAR (Ref # 92143A)	92143-1148	1
SPRING (Ref # 92144)	92144-1382	1
SPRING (Ref # 92145)	92145-1368	1
COLLAR (Ref # 92152)	92152-1075	1