

2015 Teryx4™ PARTS DIAGRAM

Headlight(s)

F2710

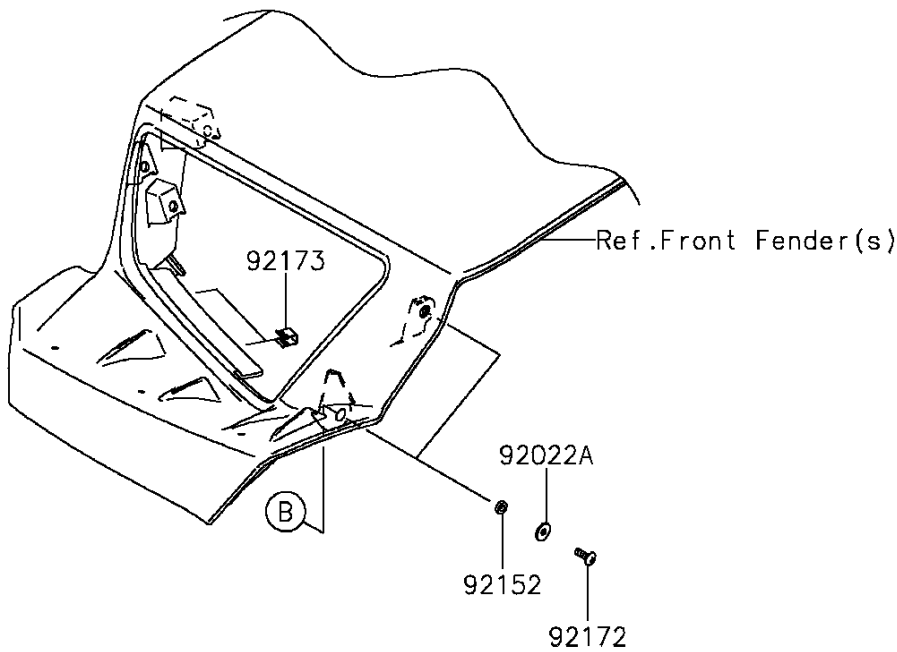

LH	(14092)
RH	(14092A)

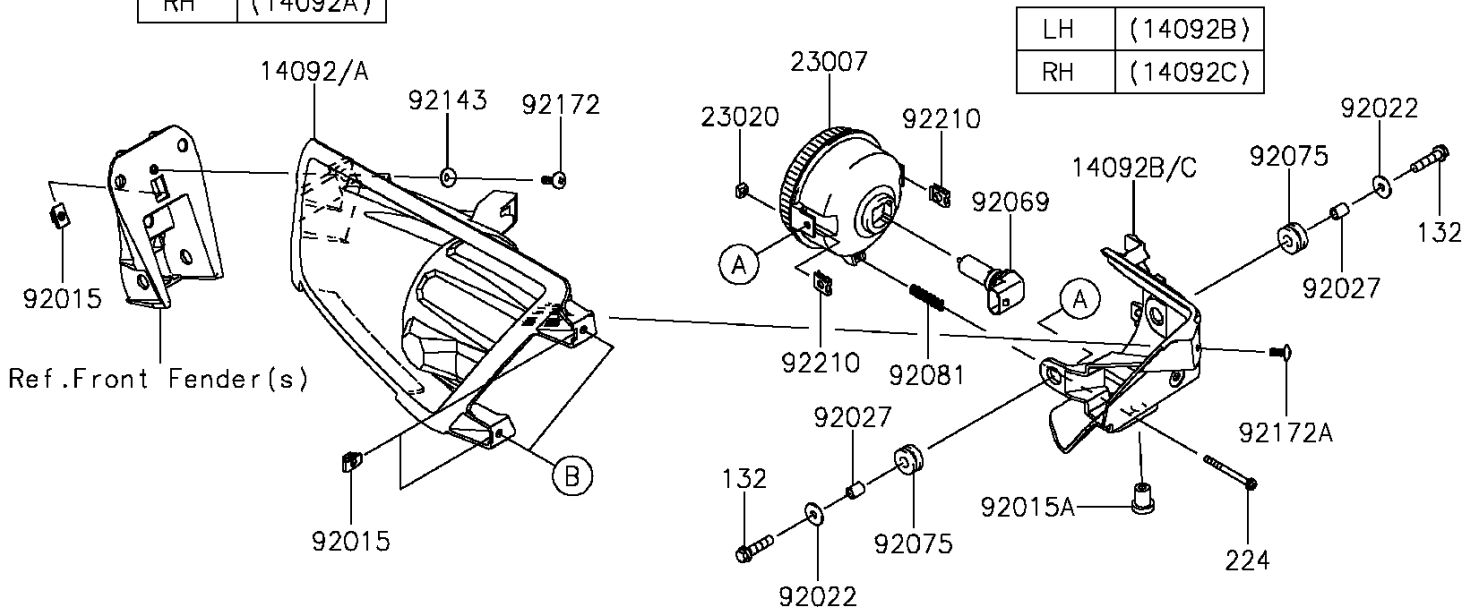

LH	(14092B)
RH	(14092C)

2015 Teryx4™ PARTS LIST

Headlight(s)

ITEM NAME	PART NUMBER	QUANTITY
BOLT-FLANGED-SMALL,6X25 (Ref # 132)	132BA0625	1
SCREW-PAN-WP-CROS,4X45 (Ref # 224)	224AA0445	1
COVER,HEAD LAMP,FR,LH (Ref # 14092)	14092-0054	1
COVER,HEAD LAMP,FR,RH (Ref # 14092A)	14092-0055	1
COVER,HEAD LAMP,RR,LH (Ref # 14092B)	14092-0056	1
COVER,HEAD LAMP,RR,RH (Ref # 14092C)	14092-0057	1
LENS-COMP,HEAD LAMP (Ref # 23007)	23007-0096	1
NUT,4MM,FOCUS ADJUST (Ref # 23020)	23020-018	1
NUT,5MM (Ref # 92015)	92015-1627	1
NUT,RUBBER,6MM (Ref # 92015A)	92015-1692	1
WASHER,6.5X20X1.6 (Ref # 92022)	92022-125	1
WASHER,5.2X16X1.2 (Ref # 92022A)	92022-263	1
COLLAR,6.8X10X12 (Ref # 92027)	92027-162	1
BULB,12V 35/35W (Ref # 92069)	92069-0019	1
DAMPER (Ref # 92075)	92075-1690	1
SPRING,FOCUS ADJUST (Ref # 92081)	92081-1896	1
COLLAR (Ref # 92143)	92143-1087	1
COLLAR,5.3X10.7X3 (Ref # 92152)	92152-1703	1
SCREW,5X16 (Ref # 92172)	92172-0322	1
SCREW,5X12 (Ref # 92172A)	92172-3714	1
CLAMP (Ref # 92173)	92173-0104	1
NUT (Ref # 92210)	92210-1125	1