

2015 NINJA® 300 ABS PARTS DIAGRAM

Footrests

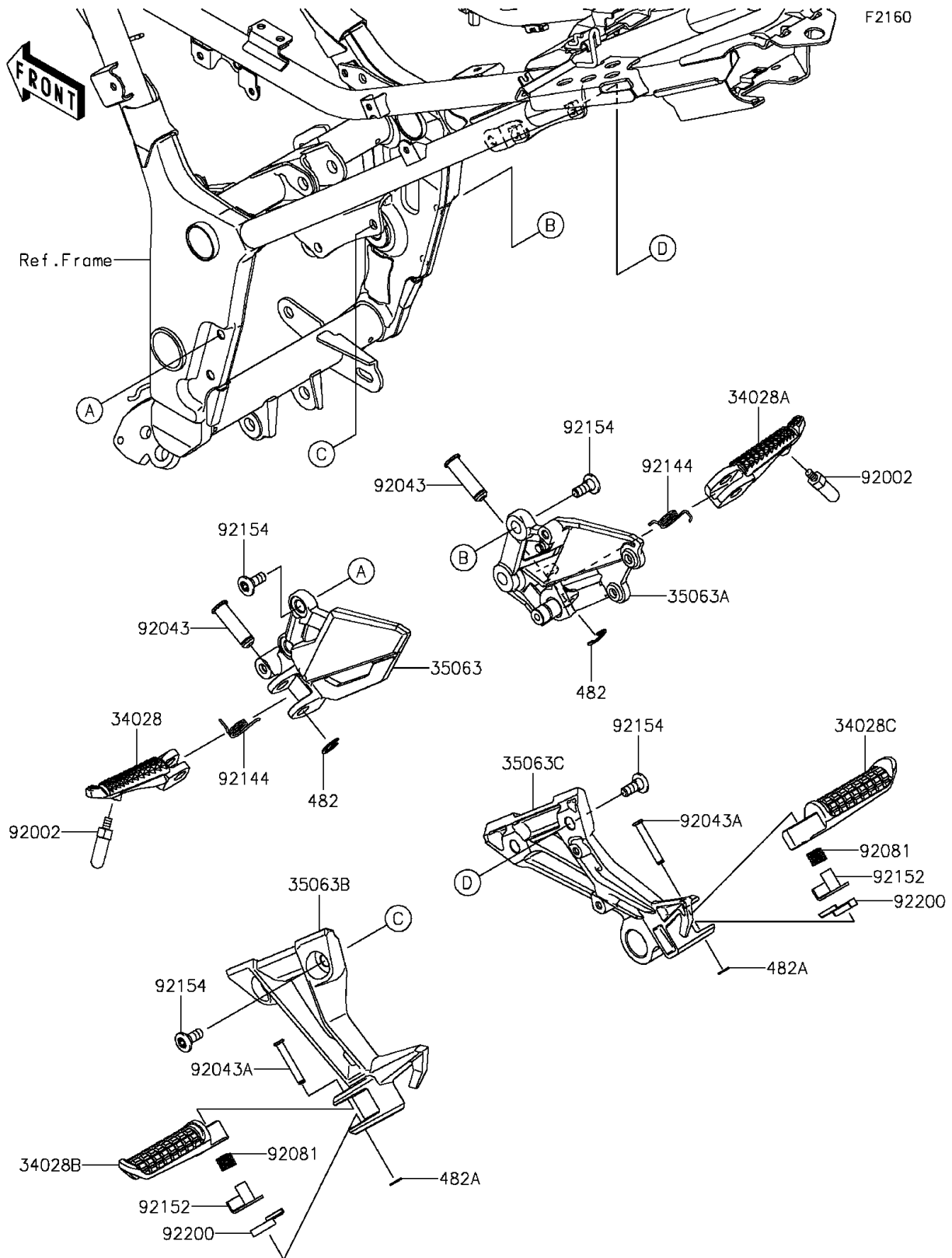

2015 NINJA® 300 ABS PARTS LIST

Footrests

ITEM NAME	PART NUMBER	QUANTITY
CIRCLIP-TYPE-E,10MM (Ref # 482)	482EA0100	1
CIRCLIP-TYPE-E (Ref # 482A)	482EA5000	1
STEP,FR,LH (Ref # 34028)	34028-0318	1
STEP,FR,RH (Ref # 34028A)	34028-0319	1
STEP,RR,LH (Ref # 34028B)	34028-1488	1
STEP,RR,RH (Ref # 34028C)	34028-1489	1
STAY,STEP HOLDER,FR,LH (Ref # 35063)	35063-0839	1
STAY,STEP HOLDER,FR,RH (Ref # 35063A)	35063-0840	1
STAY,STEP HOLDER,RR,LH (Ref # 35063B)	35063-0841	1
STAY,STEP HOLDER,RR,RH (Ref # 35063C)	35063-0842	1
BOLT,BANK SENSOR (Ref # 92002)	92002-1995	1
PIN,12X37.5 (Ref # 92043)	92043-0026	1
PIN,6X40 (Ref # 92043A)	92043-0200	1
SPRING,STEP,RR (Ref # 92081)	92081-1612	1
SPRING,STEP RETURN (Ref # 92144)	92144-1567	1
COLLAR,STEP (Ref # 92152)	92152-0658	1
BOLT,SOCKET,8X20 (Ref # 92154)	92154-0936	1
WASHER (Ref # 92200)	92200-0783	1