

## 2015 NINJA® 300 PARTS DIAGRAM

Valve(s)

E1210

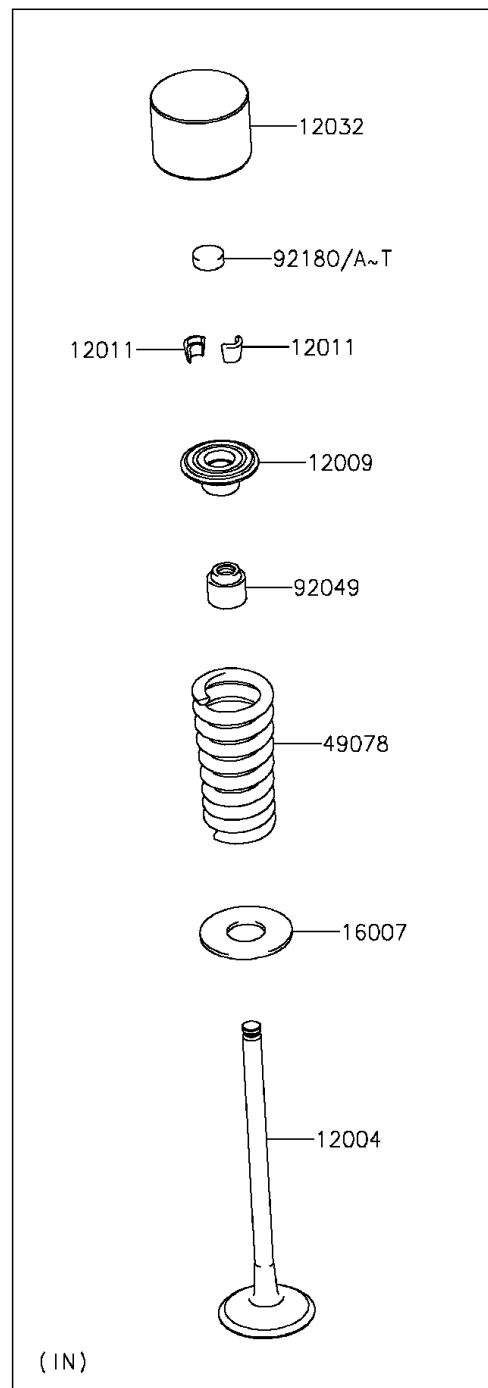
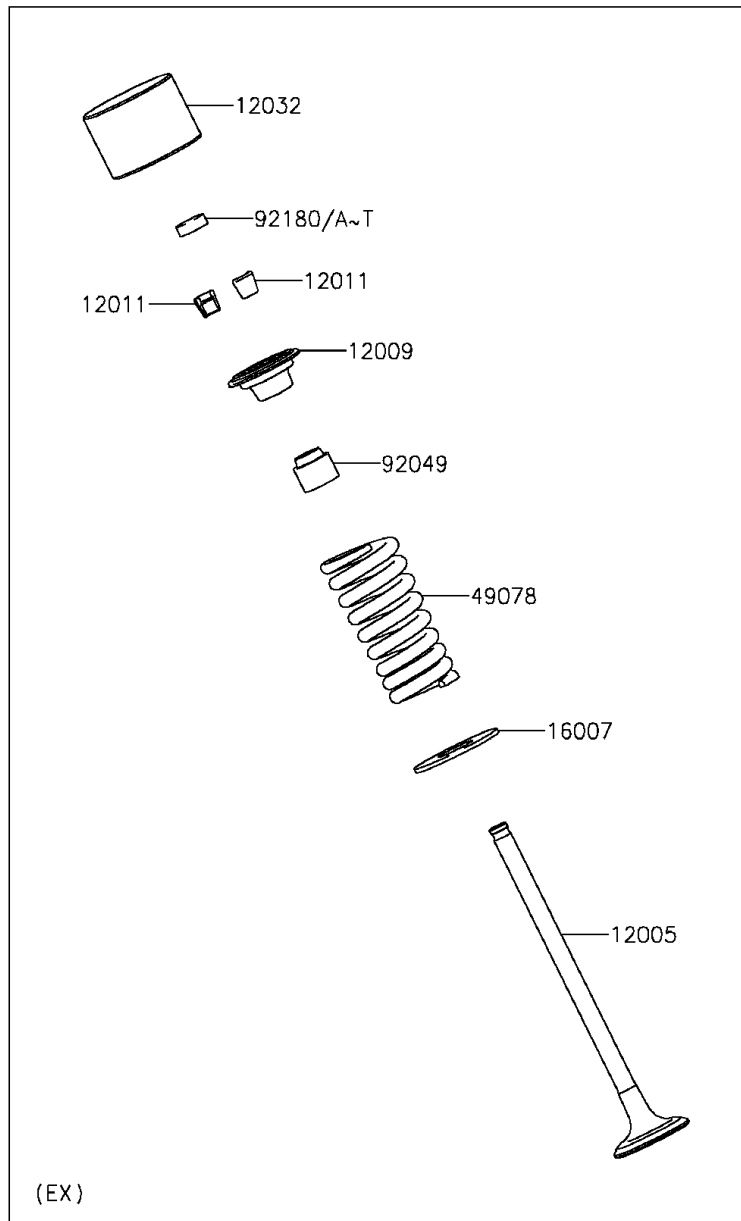

## 2015 NINJA® 300 PARTS LIST

Valve(s)

ITEM NAME	PART NUMBER	QUANTITY
VALVE-INTAKE (Ref # 12004)	12004-0716	1
VALVE-EXHAUST (Ref # 12005)	12005-0057	1
RETAINER-VALVE SPRING (Ref # 12009)	12009-1073	1
COLLET (Ref # 12011)	12011-1053	1
TAPPET (Ref # 12032)	12032-0018	1
SEAT-SPRING (Ref # 16007)	16007-0028	1
SPRING-ENGINE VALVE (Ref # 49078)	49078-0077	1
SEAL-OIL,VSB 4.3 7.5 5.3 8.3 (Ref # 92049)	92049-1349	1
SHIM,T=2.50 (Ref # 92180)	92180-1014	1
SHIM,T=2.55 (Ref # 92180A)	92180-1016	1
SHIM,T=2.60 (Ref # 92180B)	92180-1018	1
SHIM,T=2.65 (Ref # 92180C)	92180-1020	1
SHIM,T=2.70 (Ref # 92180D)	92180-1022	1
SHIM,T=2.75 (Ref # 92180E)	92180-1024	1
SHIM,T=2.80 (Ref # 92180F)	92180-1026	1
SHIM,T=2.85 (Ref # 92180G)	92180-1028	1
SHIM,T=2.90 (Ref # 92180H)	92180-1030	1
SHIM,T=2.95 (Ref # 92180I)	92180-1032	1
SHIM,T=3.00 (Ref # 92180J)	92180-1034	1
SHIM,T=3.05 (Ref # 92180K)	92180-1036	1
SHIM,T=3.10 (Ref # 92180L)	92180-1038	1
SHIM,T=3.15 (Ref # 92180M)	92180-1040	1
SHIM,T=3.20 (Ref # 92180N)	92180-1042	1
SHIM,T=3.25 (Ref # 92180O)	92180-1044	1
SHIM,T=3.30 (Ref # 92180P)	92180-1046	1
SHIM,T=3.35 (Ref # 92180Q)	92180-1048	1
SHIM,T=3.40 (Ref # 92180R)	92180-1050	1
SHIM,T=3.45 (Ref # 92180S)	92180-1052	1
SHIM,T=3.50 (Ref # 92180T)	92180-1054	1