

2001 NINJA® ZX™-12R PARTS DIAGRAM

Crankcase

E1411

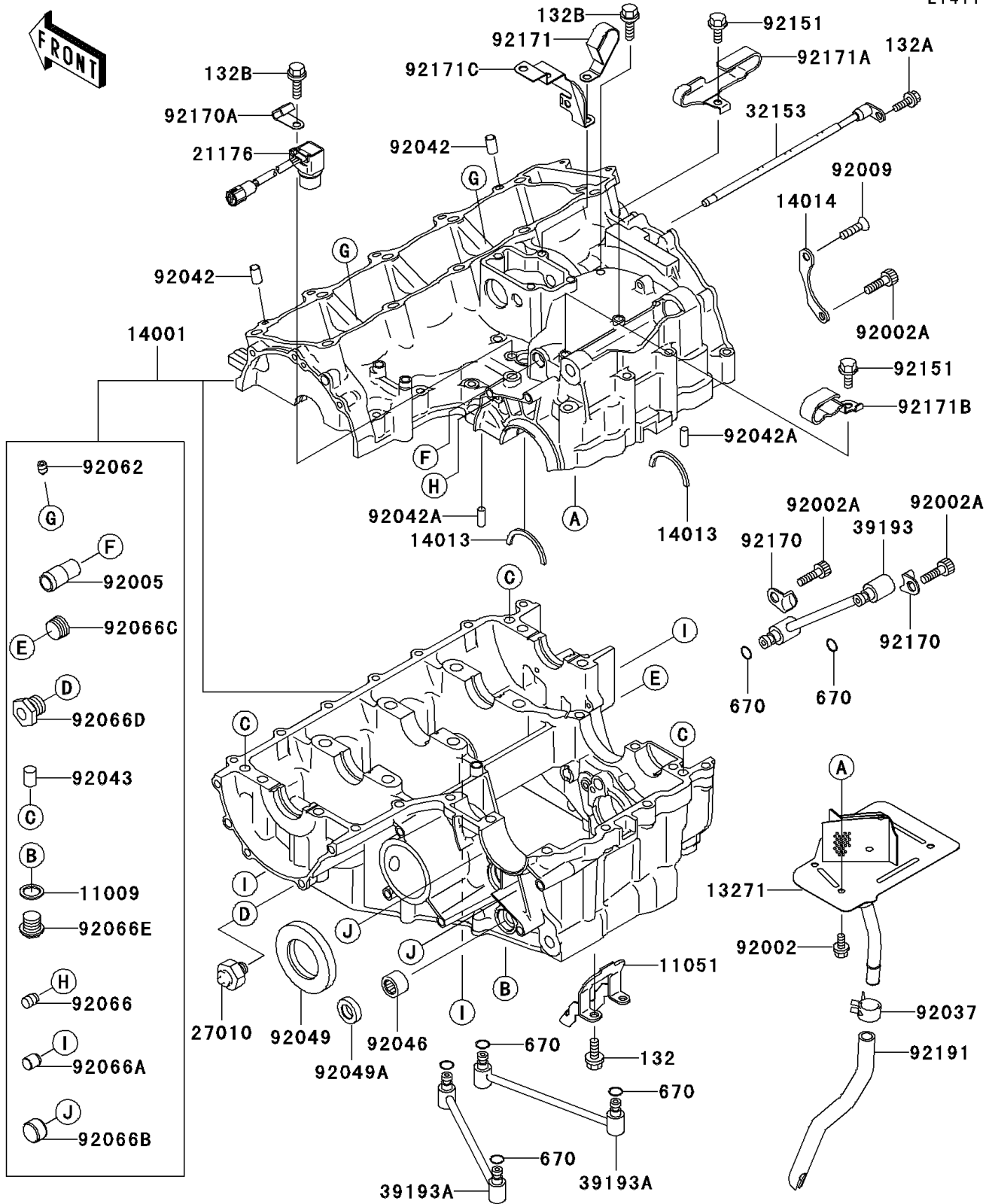

2001 NINJA® ZX™-12R PARTS LIST

Crankcase

ITEM NAME	PART NUMBER	QUANTITY
BOLT-FLANGED-SMALL (Ref # 132)	132H0612	1
BOLT-FLANGED-SMALL (Ref # 132A)	132Y0614	1
GASKET,14X19.5X1.4 (Ref # 11009)	11009-1461	1
BRACKET,TUBE (Ref # 11051)	11051-1334	1
PLATE,BREATHER (Ref # 13271)	13271-1228	1
SET-CRANKCASE (Ref # 14001)	14001-1286	1
RING-POSITION,T=1.98 (Ref # 14013)	14013-1004	1
PLATE-POSITION (Ref # 14014)	14014-1140	1
SENSOR,SPEEDOMETER (Ref # 21176)	21176-1106	1
SWITCH,OIL PRESSURE (Ref # 27010)	27010-1313	1
PIPE,OIL (Ref # 32153)	32153-1139	1
PIPE-OIL (Ref # 39193)	39193-1020	1
PIPE-OIL,OIL PAN (Ref # 39193A)	39193-1047	1
BOLT,6X10 (Ref # 92002)	92002-1449	1
BOLT,SOCKET,6X16 (Ref # 92002A)	92002-1778	1
FITTING,BREATHER (Ref # 92005)	92005-1238	1
SCREW,6X16 (Ref # 92009)	92009-1360	1
CLAMP (Ref # 92037)	92037-1678	1
PIN,DOWEL,6.3X8X14 (Ref # 92042)	92042-007	1
PIN,DOWEL,6X16 (Ref # 92042A)	92042-016	1
PIN (Ref # 92043)	92043-1506	1
BEARING-NEEDLE,HK1312 (Ref # 92046)	92046-1148	1
SEAL-OIL,SD40X62X8 (Ref # 92049)	92049-1510	1
SEAL-OIL,TC13225.5 (Ref # 92049A)	92049-1519	1
NOZZLE,5X6,SILVER (Ref # 92062)	92062-1086	1
PLUG (Ref # 92066)	92066-042	1
PLUG,OIL LINE,7.2X8 (Ref # 92066A)	92066-1012	1
PLUG (Ref # 92066B)	92066-1110	1
PLUG,PT3/8X12 (Ref # 92066C)	92066-1252	1

2001 NINJA® ZX™-12R PARTS LIST

Crankcase

ITEM NAME	PART NUMBER	QUANTITY
PLUG,PT3/8X3 (Ref # 92066D)	92066-1513	1
PLUG,DRAIN (Ref # 92066E)	92066-2196	1
BOLT,6X12 (Ref # 92151)	92151-1239	1
CLAMP (Ref # 92170)	92170-1578	1
CLAMP,HARNESS (Ref # 92170A)	92170-1900	1
CLAMP (Ref # 92171)	92171-1099	1
CLAMP (Ref # 92171A)	92171-1133	1
CLAMP (Ref # 92171B)	92171-1216	1
CLAMP (Ref # 92171C)	92171-1217	1
TUBE,BREATHER (Ref # 92191)	92191-1602	1
BOLT-FLANGED-SMALL (Ref # 132B)	132Y0616	1
O RING (Ref # 670)	670D1505	1