

1980 KZ250 PARTS DIAGRAM

FRONT HUB/BRAKE ('80 D1)

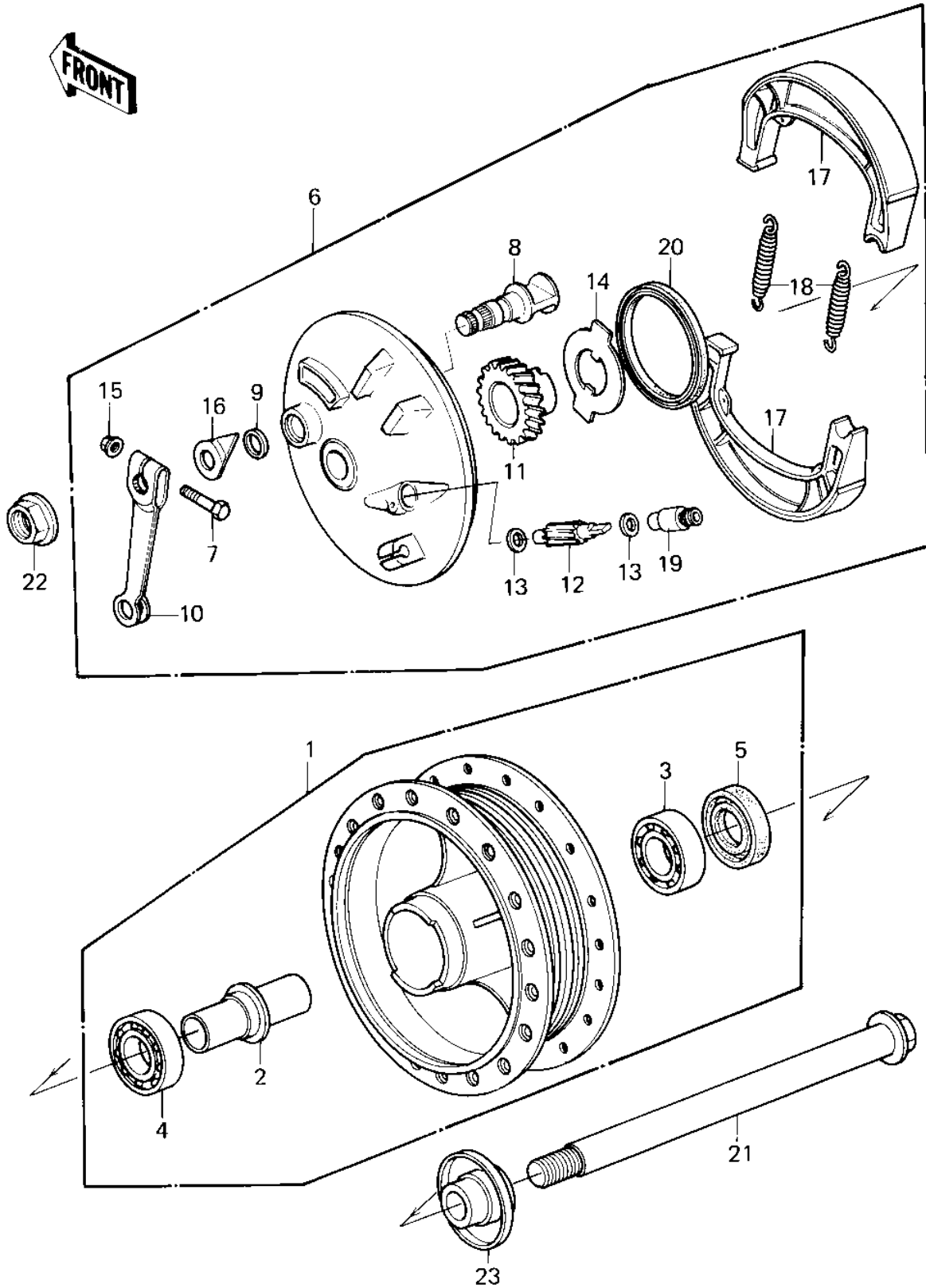

1980 KZ250 PARTS LIST

FRONT HUB/BRAKE ('80 D1)

ITEM NAME	PART NUMBER	QUANTITY
DRUM-ASSY,FR BRK,BUFF (Ref # 1)	41034-048-80	1
SPACER FR HUB BEARING (Ref # 2)	41039-004	1
BEARING BALL #6202 (Ref # 3)	601B6202	1
BEARING BALL #6202Z (Ref # 4)	601B6202Z	1
OIL SEAL RR BRK DRUM (Ref # 5)	92050-008	1
PANEL-ASY,FR BRK (Ref # 6)	41035-1028	1
BOLT-UPSET,6X35 (Ref # 7)	112G0635	1
CAM SHAFT,FR BRAKE (Ref # 8)	41050-1015	1
DUST SHIELD BRAKE CAM (Ref # 9)	41051-001	1
LEVER,FR BRAKE CAM (Ref # 10)	41053-1017	1
GEAR,SPEEDOMETER 29T (Ref # 11)	41060-1027	1
PINION,SPEEDOMET,11T (Ref # 12)	41060-1028	1
WASHER THRST SPD PINI (Ref # 13)	41063-001	1
RECIEVER GEAR (Ref # 14)	41064-003	1
NUT,6MM (Ref # 15)	41072-007	1
INDICATOR,FR BRK PNL (Ref # 16)	41085-005	1
SHOE,BRAKE (Ref # 17)	42019-011	1
SPRING-BRAKE SHOE (Ref # 18)	42020-004	1
BUSHING,SPEEDOMET CBL (Ref # 19)	92028-1066	1
OIL SEAL F BRK PANEL (Ref # 20)	92050-010	1
AXLE,FRONT (Ref # 21)	41068-1029	1
NUT,14MM (Ref # 22)	92015-1407	1
COLLAR,FR AXLE (Ref # 23)	92027-1218	1