

1980 KZ250 PARTS DIAGRAM

GEAR CHANGE MECHANISM ('80 D1)

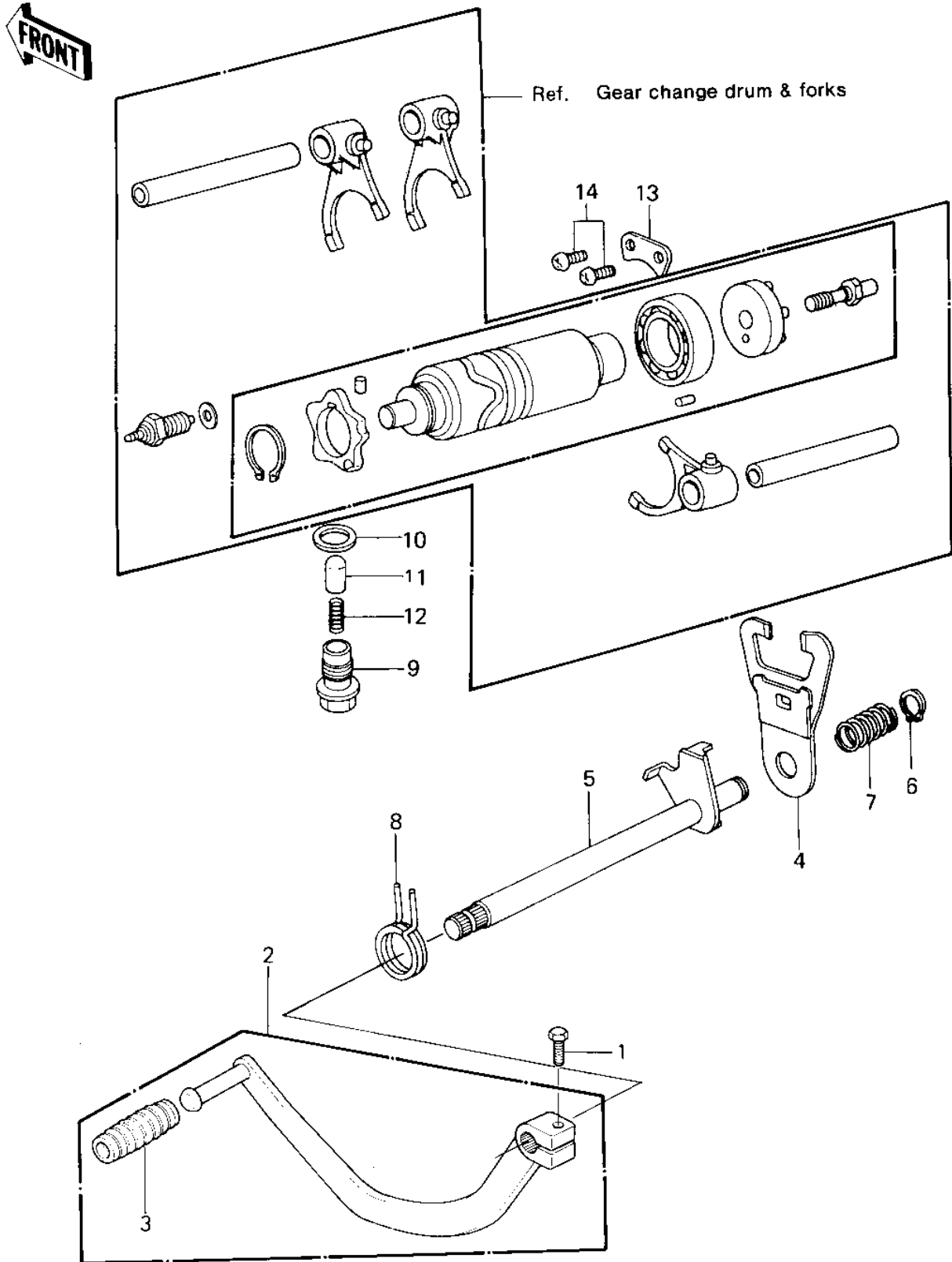

1980 KZ250 PARTS LIST

GEAR CHANGE MECHANISM ('80 D1)

ITEM NAME	PART NUMBER	QUANTITY
BOLT-UPSET,6X20 (Ref # 1)	112G0620	1
LEVER ASSY,GEAR SHIFT (Ref # 2)	13242-1020	1
DAMPER,CHANGE PEDAL (Ref # 3)	92160-1036	1
LEVER ASSY,GEAR SHIFT (Ref # 4)	13161-044	1
LEVER ASSY,GEAR SHIFT (Ref # 5)	13161-1013	1
CIRCLIP,13MM (Ref # 6)	480J1300	1
SPRING,COIL (Ref # 7)	92081-149	1
SPRING,CHG PEDL RTRN (Ref # 8)	92083-028	1
BOLT,NEUTRAL POSITION (Ref # 9)	92001-182	1
WASHER,PLAIN (Ref # 10)	92022-324	1
PIN,NEUTRAL POSITIONG (Ref # 11)	92043-131	1
SPRING (Ref # 12)	92081-112	1
PLATE,GEAR CHANGE (Ref # 13)	13169-014	1
SCREW PAN HEAD 6X14 (Ref # 14)	220B0614	1