

1986 KL600 PARTS DIAGRAM

GENERATOR/REGULATOR

E1810-0132

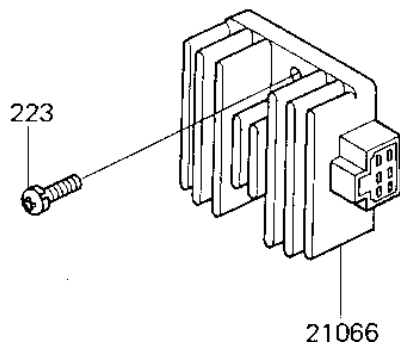
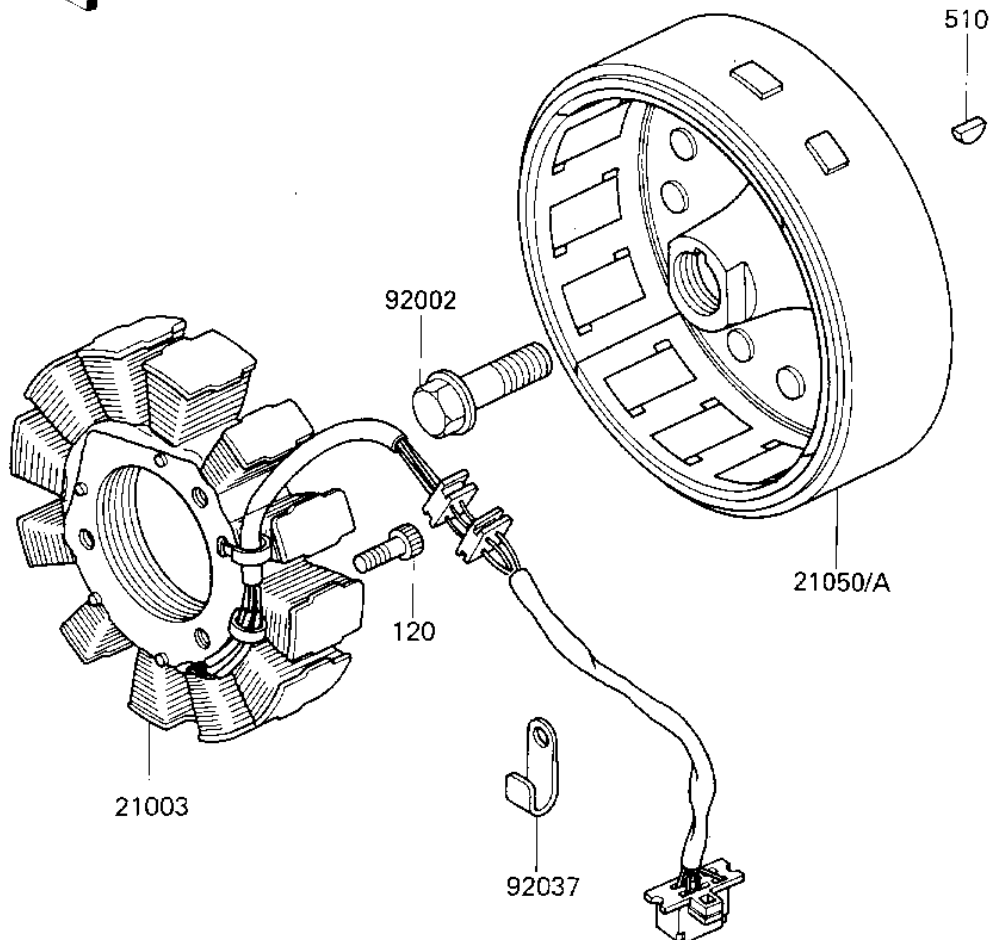

1986 KL600 PARTS LIST

GENERATOR/REGULATOR

ITEM NAME	PART NUMBER	QUANTITY
STATOR (Ref # 21003)	21003-1130	1
FLYWHEEL (Ref # 21050A)	21050-1118	1
REGULATOR-VOLTAGE (Ref # 21066)	21066-1038	1
BOLT (Ref # 92002)	92002-1693	1
CLAMP,WIRING HARNESS (Ref # 92037)	21126-008	1
BOLT,ALLEN,6X28 (Ref # 120)	120P0628	1
SCREW-PAN-WS-CROS (Ref # 223)	223B0625	1
KEY,WOODRUFF (Ref # 510)	510A4200	1