

1982 KE125 PARTS DIAGRAM

HEADLIGHT ('82-'83 A9/A10)

F2710-0064

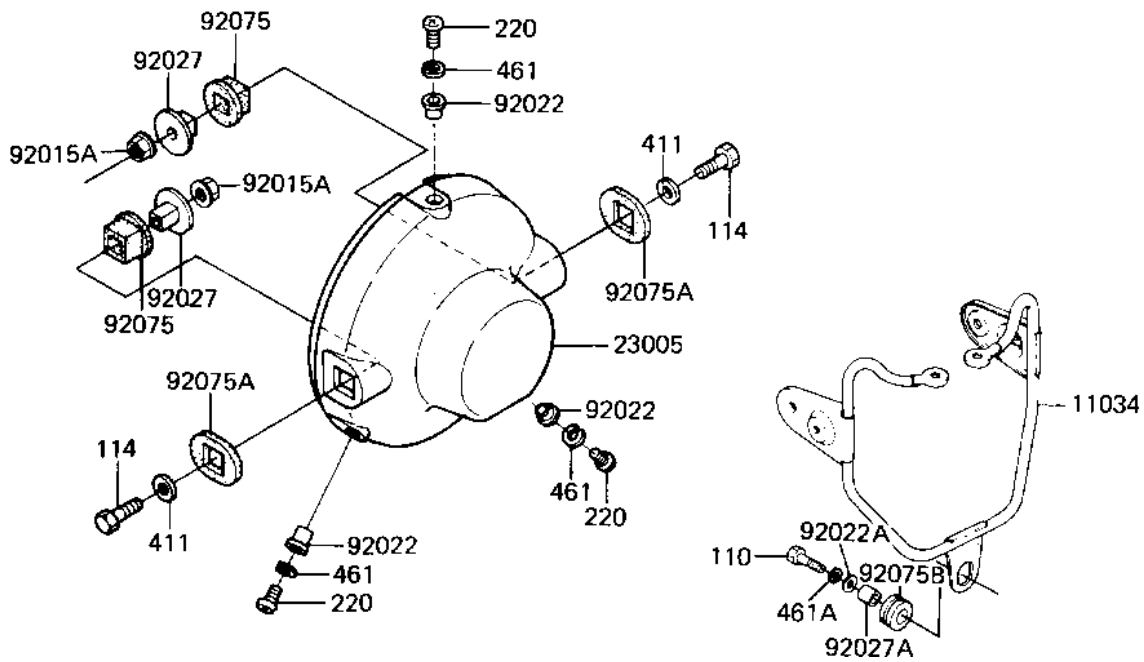
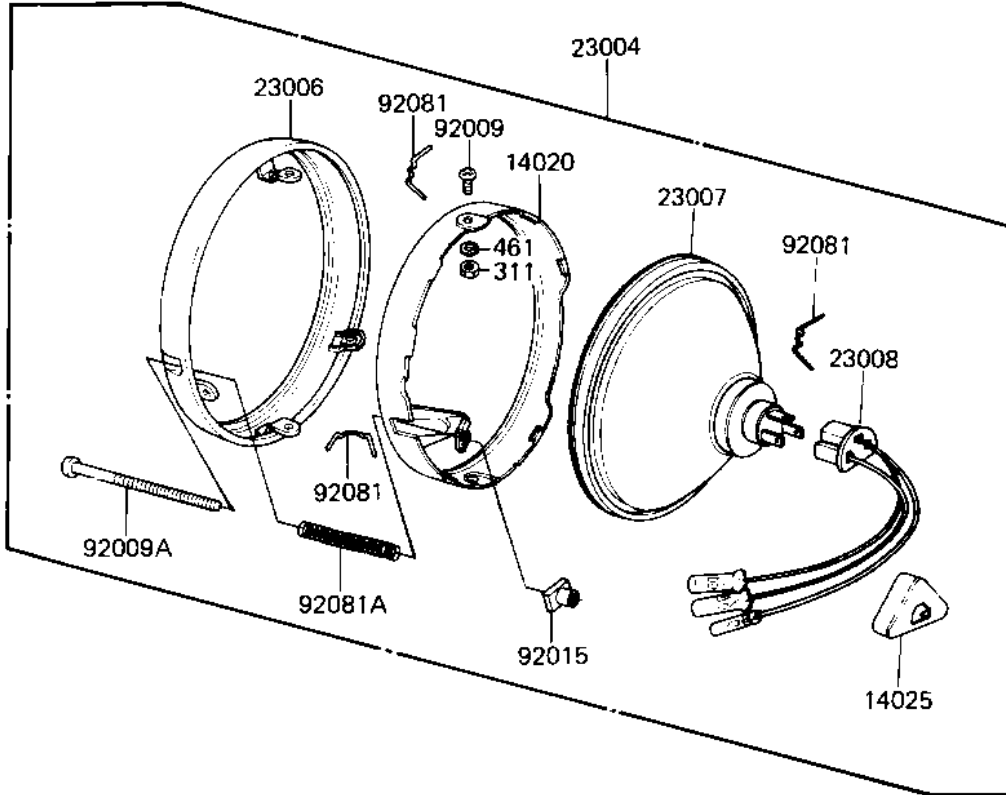

1982 KE125 PARTS LIST

HEADLIGHT ('82-'83 A9/A10)

ITEM NAME	PART NUMBER	QUANTITY
BRACKET,HEAD LMP BODY (Ref # 11034)	11034-1701	1
RETAINER,SEALED BEAM (Ref # 14020)	23072-002	1
COVER,HD LAMP SOCKET (Ref # 14025)	23081-001	1
LAMP UNIT,HEAD (Ref # 23004)	23004-1030	1
BODY,HEAD LAMP,BLACK (Ref # 23005)	23005-1007-6Z	1
RIM,HEAD LAMP (Ref # 23006)	23006-1004	1
SEALED BEAM UNIT (Ref # 23007)	23007-055	1
SOCKET ASSY,HD LIGHT (Ref # 23008)	23008-044	1
SCREW,LENS FITTING (Ref # 92009)	23019-026	1
SCREW,FOCUS ADJUST (Ref # 92009A)	23019-027	1
NUT ADJUST (Ref # 92015)	23020-012	1
NUT,8M/M (Ref # 92015A)	92015-1014	1
WASHER (Ref # 92022)	23021-010	1
WASHER 6.5X20X1.6T (Ref # 92022A)	92022-125	1
COLLAR,HEAD LAMP (Ref # 92027)	92027-1105	1
COLLAR,REAR FENDER (Ref # 92072A)	92027-162	1
DAMPER RUBBER,HD LAMP (Ref # 92075)	92075-1077	1
DAMPER,BATTERY BASE (Ref # 92075A)	92075-1076	1
DAMPER RUBBER,RR FENR (Ref # 92075B)	92075-209	1
CLAMP,HEAD LAMP LENS (Ref # 92081)	23009-015	1
SPRING,FOCUS ADJUST (Ref # 92081A)	23014-012	1
BOLT-UPSET (Ref # 110)	112G0625	1
BOLT-SMALL,8X30 (Ref # 114)	114N0830	1
SCREW PAN HEAD 5X12 (Ref # 220)	220B0512	1
NUT,4MM (Ref # 311)	311B0400	1
WASHER,PLAIN,8MM (Ref # 411)	411D0800	1
WASHER SPRING 5MM (Ref # 461)	461F0500	1
WASHER SPRING 6MM (Ref # 461A)	461F0600	1