

1988 NINJA® 250R PARTS DIAGRAM

Generator

E1810-0151

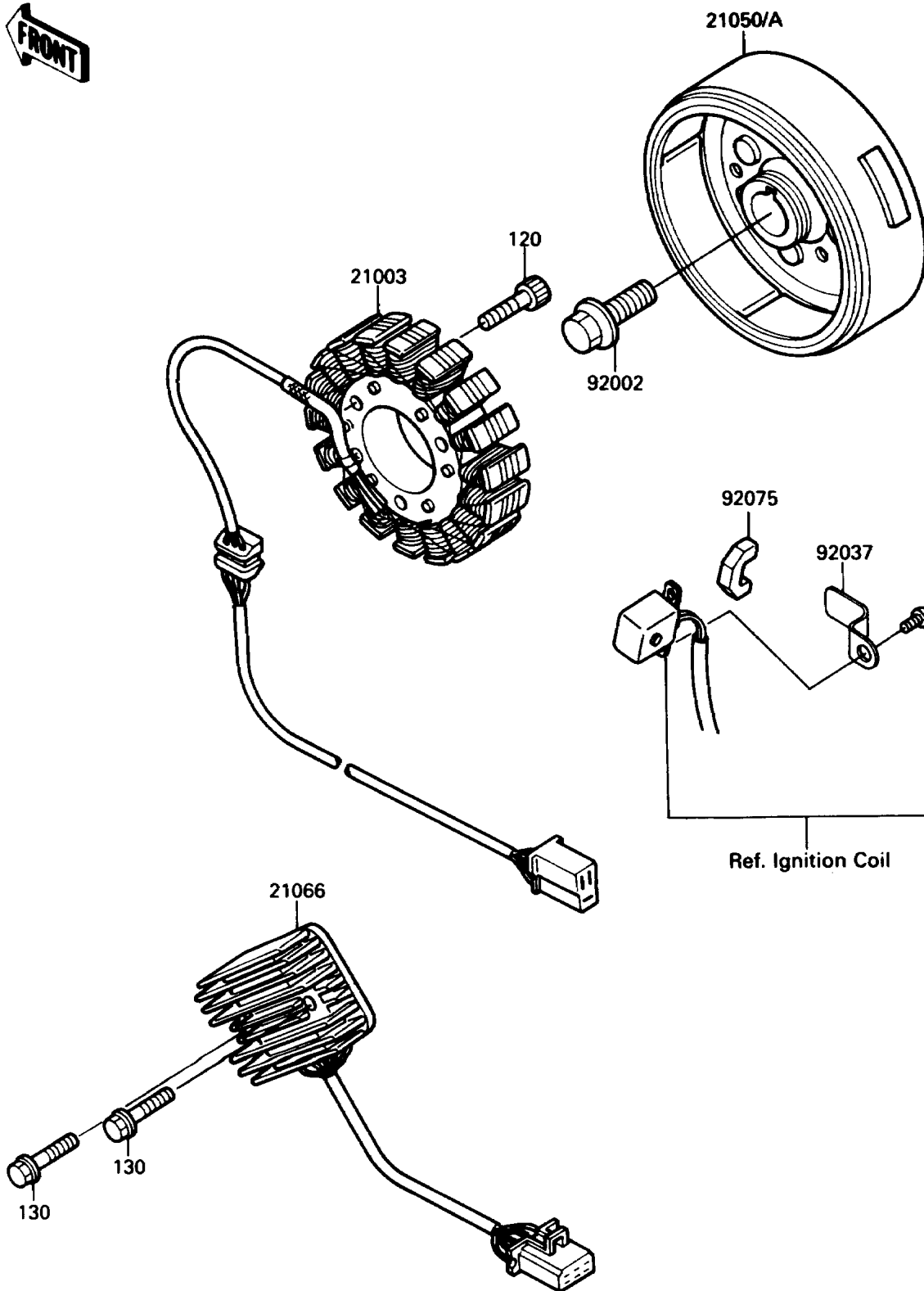

1988 NINJA® 250R PARTS LIST

Generator

ITEM NAME	PART NUMBER	QUANTITY
STATOR (Ref # 21003)	21003-1154	1
FLYWHEEL (Ref # 21050)	21050-1129	1
FLYWHEEL (Ref # 21050A)	21050-1134	1
REGULATOR-VOLTAGE (Ref # 21066)	21066-1030	1
BOLT,10X28 (Ref # 92002)	92002-1688	1
CLAMP (Ref # 92037)	92037-1919	1
DAMPER (Ref # 92075)	92075-1811	1
BOLT-SOCKET,6X25 (Ref # 120)	120P0625	1
BOLT-FLANGED,6X25 (Ref # 130)	130B0625	1