

1996 NINJA® 250R PARTS DIAGRAM

Front Master Cylinder

F2291

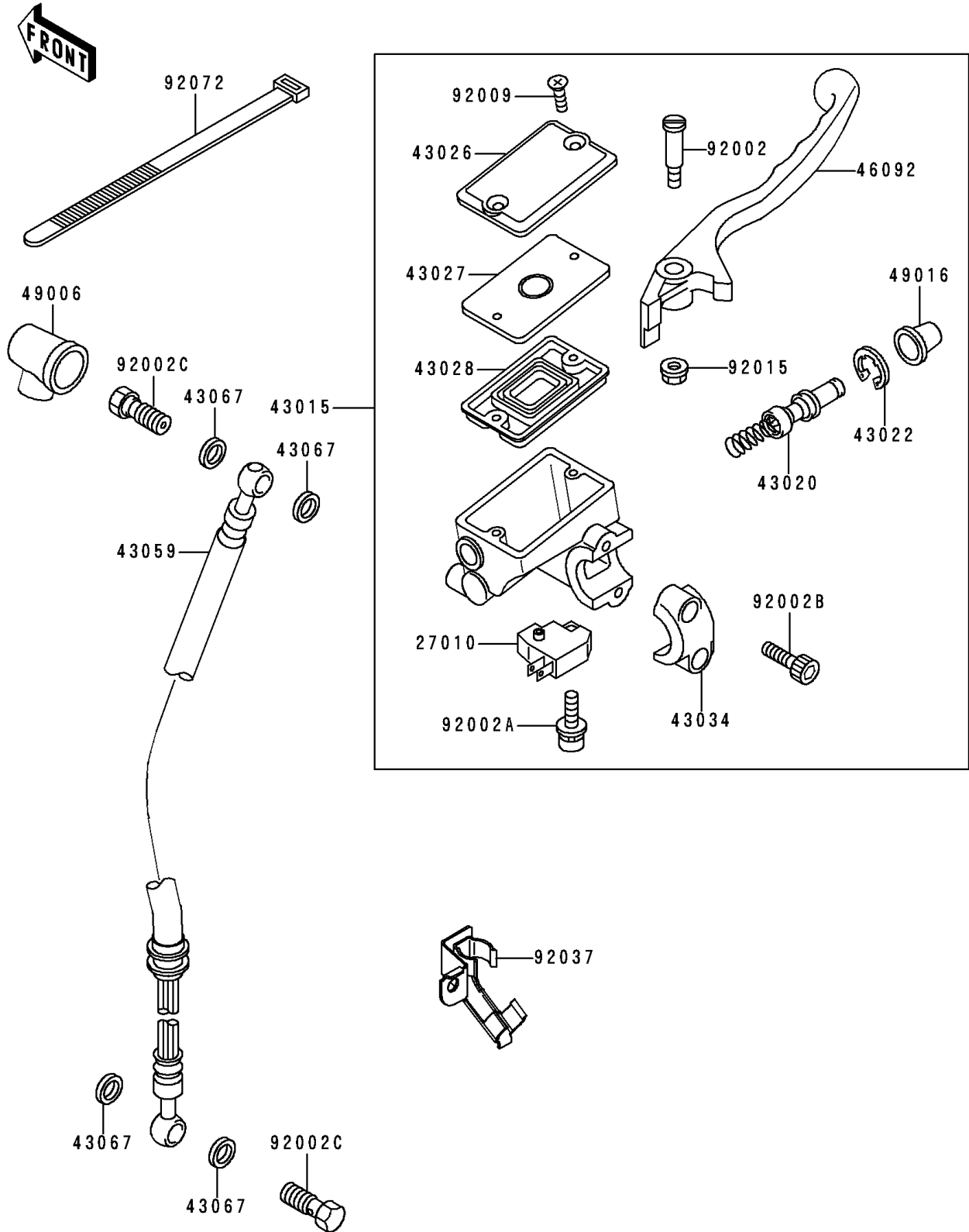

1996 NINJA® 250R PARTS LIST

Front Master Cylinder

ITEM NAME	PART NUMBER	QUANTITY
SWITCH,BRAKE (Ref # 27010)	27010-1170	1
CYLINDER-ASSY-MASTER,FR (Ref # 43015)	43015-1494	1
PISTON-COMP-BRAKE (Ref # 43020)	43020-1031	1
STOPPER-BRAKE,PISTON (Ref # 43022)	43022-1010	1
CAP-BRAKE (Ref # 43026)	43026-1076	1
PLATE-DIAPHRAGM (Ref # 43027)	43027-1055	1
DIAPHRAGM,MASTER CYLINDER (Ref # 43028)	43028-1058	1
HOLDER-BRAKE,MASTER CYLINDER (Ref # 43034)	43034-1053	1
HOSE-BRAKE,FR (Ref # 43059)	43059-1882	1
WASHER,10.5X15X1.5 (Ref # 43067)	43067-001	1
LEVER-GRIP,FRONT BRAKE (Ref # 46092)	46092-1117	1
BOOT,DUST (Ref # 49006)	49006-1040	1
COVER-SEAL,MASTER CYLINDER (Ref # 49016)	49016-1044	1
BOLT,LEVER SET,BLACK (Ref # 92002)	92002-1322	1
BOLT,SCREW,4X12 (Ref # 92002A)	92002-1323	1
BOLT,SOCKET,6X20,BLACK (Ref # 92002B)	92002-1324	1
BOLT,OIL,L=23 (Ref # 92002C)	92002-1888	1
SCREW,4MM (Ref # 92009)	92009-1458	1
NUT,FLANGED,6MM,BLACK (Ref # 92015)	92015-1233	1
CLAMP,HOSE (Ref # 92037)	92037-1852	1
BAND,L=365 (Ref # 92072)	92072-1197	1