

# 2024 KLR650 S ABS

## PARTS DIAGRAM

### Water Pump

E3031

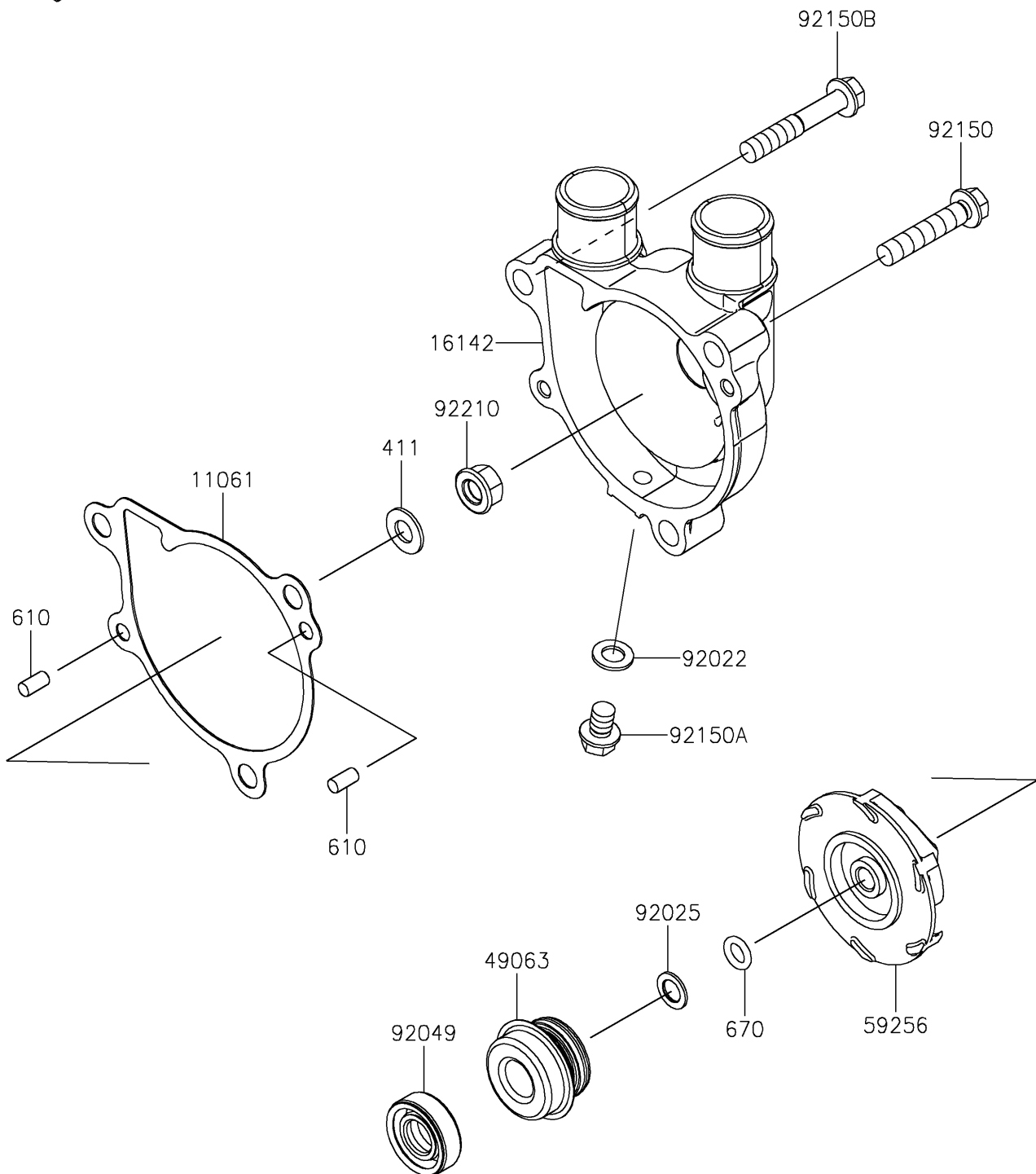

# 2024 KLR650 S ABS

## PARTS LIST

### Water Pump

**ITEM NAME**

**PART NUMBER**

**QUANTITY**

---