

# 2020 VULCAN® S ABS CAFE

## PARTS DIAGRAM

Meter(s)

F2530

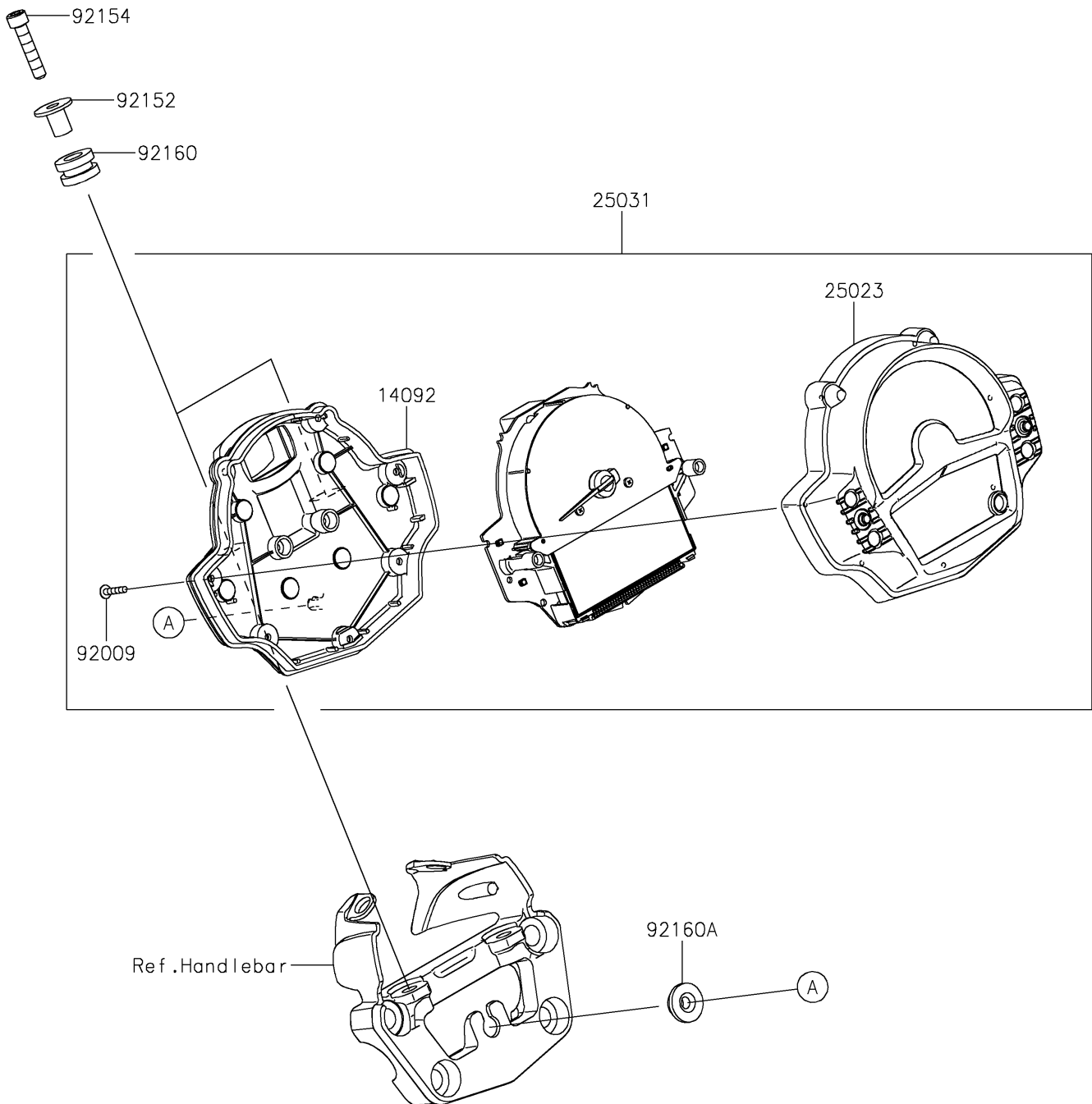

# 2020 VULCAN<sup>®</sup> S ABS CAFE

## PARTS LIST

Meter(s)

**ITEM NAME**

**PART NUMBER**

**QUANTITY**

---